

Verkleidungsprofile

Panel sections

Nut und Feder

Groove and tongue

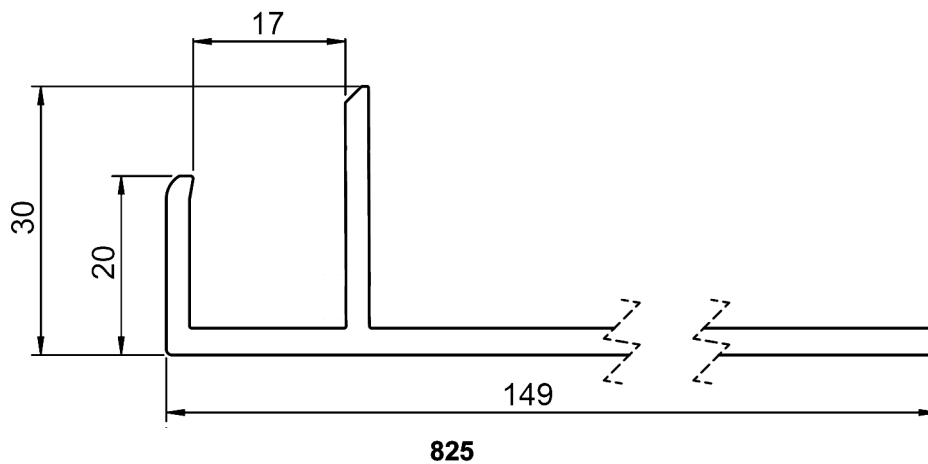
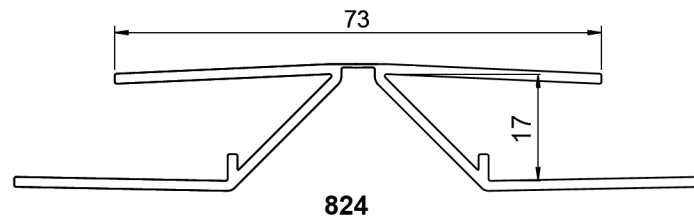
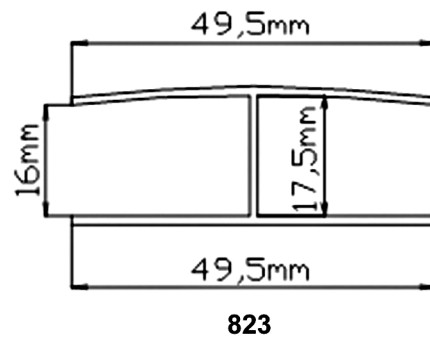
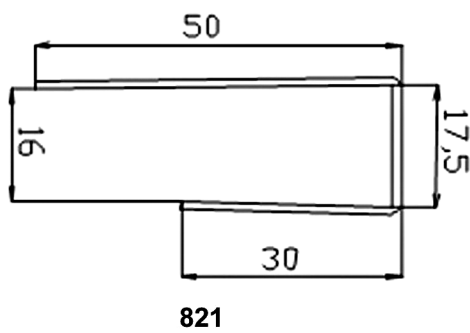
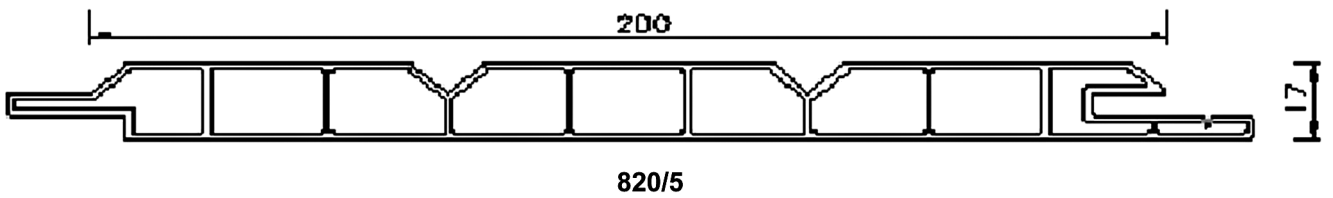
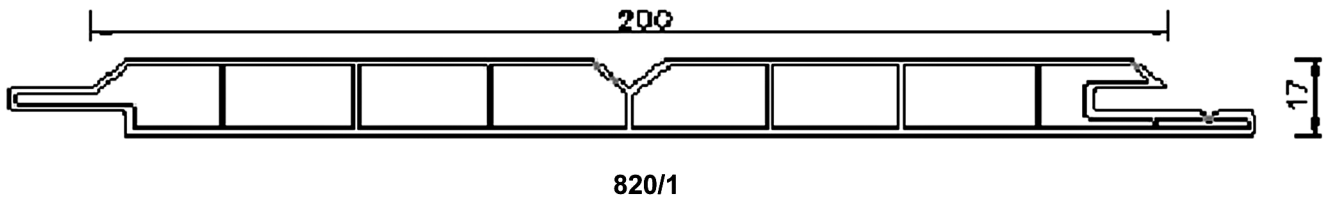











Verkleidungsprofile

Panel sections

Nut und Feder

Groove and tongue

Art.-Nr. Cat. - No.	Verkleidungsprofile Panel sections	Packung / lfm. Package / mtr.	Ausführung Execution	Lieferung Delivery
820/1	200 x 17 mm	30	○	
820/1	200 x 17 mm	30	● D	
820/5	200 x 17 mm	30	○	
821	U - Profil	60	○	
821	U - Profil	30	● D	
823	H - Profil	60	○	
823	H - Profil	30	● D	
824	Eckprofil für Art. 820	60	○	
824	Eckprofil für Art. 820	30	● D	
825	F - Profil für Art. 820	30	○	

- Dekoroberflächen - Lieferung auf Anfrage - Keine generelle Bevorratung
- Bitte immer vollständige Folien-Nr. bei der Anfrage angeben!

- Deco finished on request, not generally stocked
- Please always specify complete foil number with your inquiry!

Verkleidungsprofile

Panel sections

Türfüllungsprofile

Door sections

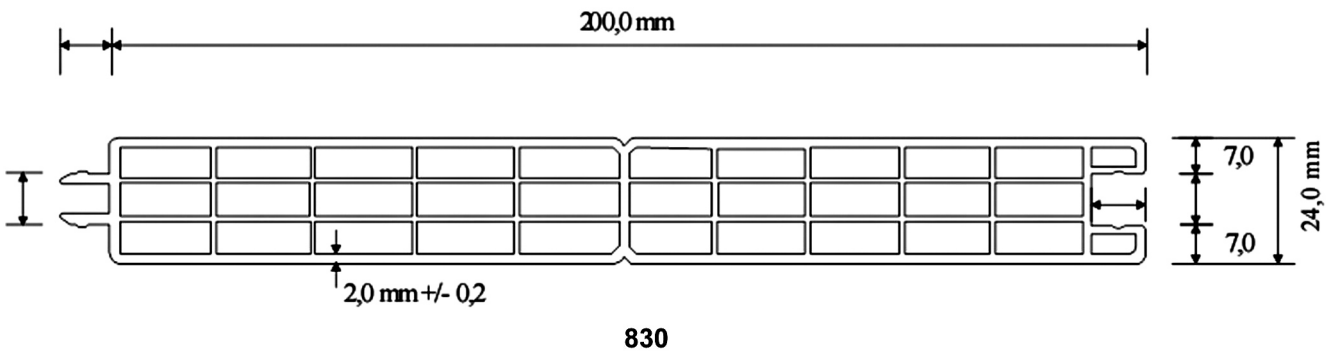
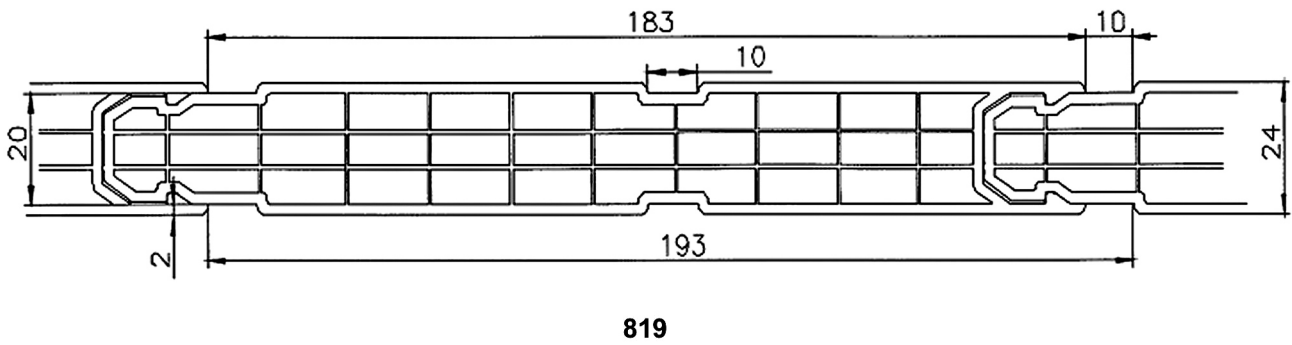







Verkleidungsprofile

Panel sections

Türfüllungsprofile

Door sections

Art.-Nr. Cat. - No.	Verkleidungsprofile Panel sections	Packung / lfm. Package / mtr.	Ausführung Execution	Lieferung Delivery
819	190 x 24 mm	12	○	
819	190 x 24 mm	12	ⓓ ES	
819	190 x 24 mm	12	ⓓ ZS	
830	200 x 24 mm	12	○	
830	200 x 24 mm	12	ⓓ ES	
830	200 x 24 mm	12	ⓓ ZS	

ES - einseitig kaschiert / one-side laminated

ZS - zweiseitig kaschiert / two-side laminated

- Dekoroberflächen - Lieferung auf Anfrage ab 120 m möglich wenn nicht ab Lager lieferbar !
- Bitte immer vollständige Folien-Nr. bei der Anfrage angeben!

- Decorative surfaces - on request from 120 m possible if not in stock!
- Please always specify complete foil number with your inquiry!

Sonderprofile

Special profiles

in RAL 9001

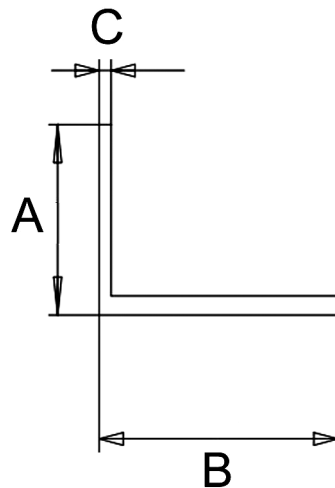
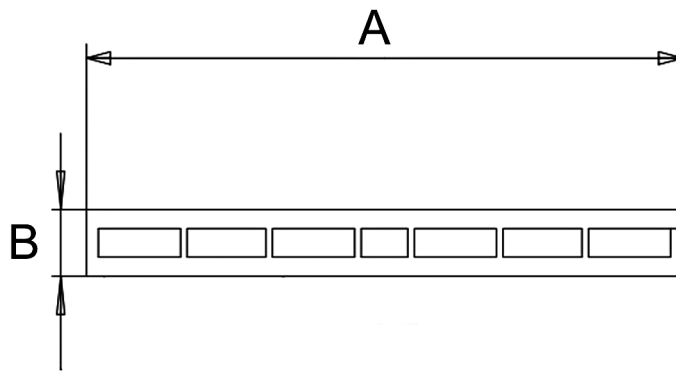
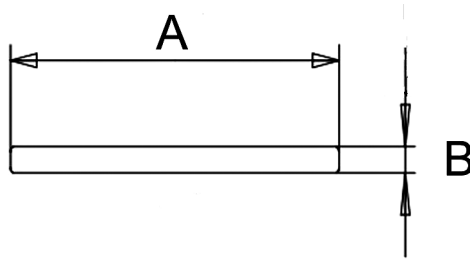





Sonderprofile



Special profiles

in RAL 9001



Flachleisten / flat strips

Art.-Nr. Cat. - No.	Sonderprofil A x B Special profile	Packung / lfm. Package / mtr.	Ausführung Execution	Lieferung Delivery
101	20 x 2,5 mm	180	RAL 9001	
103	30 x 2,5 mm	120	RAL 9001	
114	40 x 2,5 mm	90	RAL 9001	
104	50 x 2,5 mm	60	RAL 9001	

Hohlkammerleisten / cavity strips

Art.-Nr. Cat. - No.	Sonderprofil A x B Special profile	Packung / lfm. Package / mtr.	Ausführung Execution	Lieferung Delivery
204	60 x 7 mm	60	RAL 9001	
222	80 x 7 mm	60	RAL 9001	
226	100 x 7 mm	60	RAL 9001	

Winkel / angles

Art.-Nr. Cat. - No.	Sonderprofil A x B x C Special profile	Packung / lfm. Package / mtr.	Ausführung Execution	Lieferung Delivery
327	20 x 20 x 2 mm	60	RAL 9001	
329	40 x 20 x 2 mm	60	RAL 9001	
321	30 x 30 x 2 mm	60	RAL 9001	





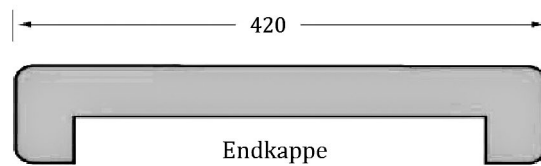
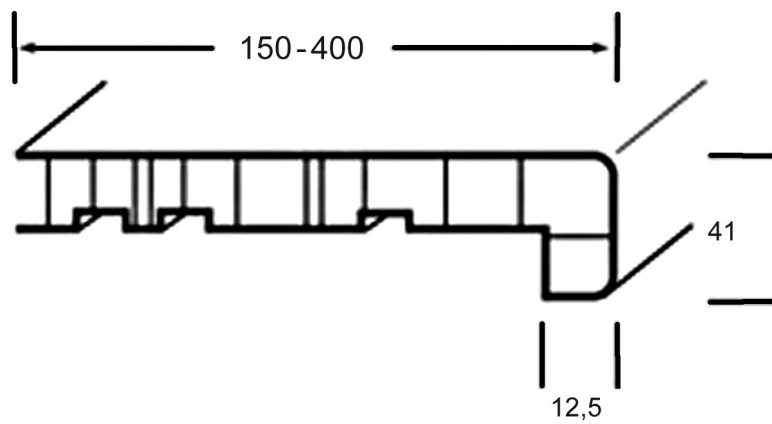

Fensterbänke

Window sills



Fensterbänke

Window sills

Art.-Nr. Cat. - No.	Sonderprofil Special profile	Packung / lfm. Package / mtr.	Ausführung Execution	Lieferung Delivery
760	150 mm	12	<input type="radio"/>	
761	200 mm	12	<input type="radio"/>	
762	250 mm	12	<input type="radio"/>	
763	300 mm	12	<input type="radio"/>	
764	350 mm	12	<input type="radio"/>	
765	400 mm	12	<input type="radio"/>	
768	Endkappe 420 mm	20 Stk./pcs	<input type="radio"/>	

Sonder- u. Verkleidungsprofile
Special and panel solutions

Sonderprofil

Special profiles

Nut- und Federprofil geschäumt

Groove and tongue profile

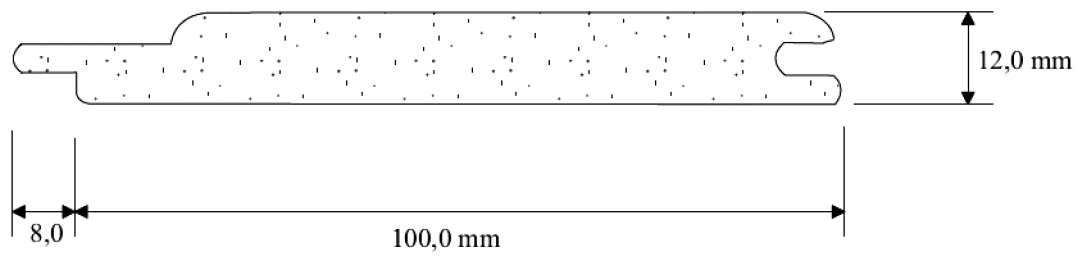





070

Sonderprofil

Special profiles

Nut- und Federprofil geschäumt

Groove and tongue profile

Art.-Nr. Cat. - No.	Sonderprofil Special profile	Packung / lfm. Package / mtr.	Ausführung Execution	Lieferung Delivery
070	100 x 12 mm	30		
070	100 x 12 mm	30	 beidseitig	

Verkleidungsprofile

Panel sections

Nut und Feder

Groove and tongue

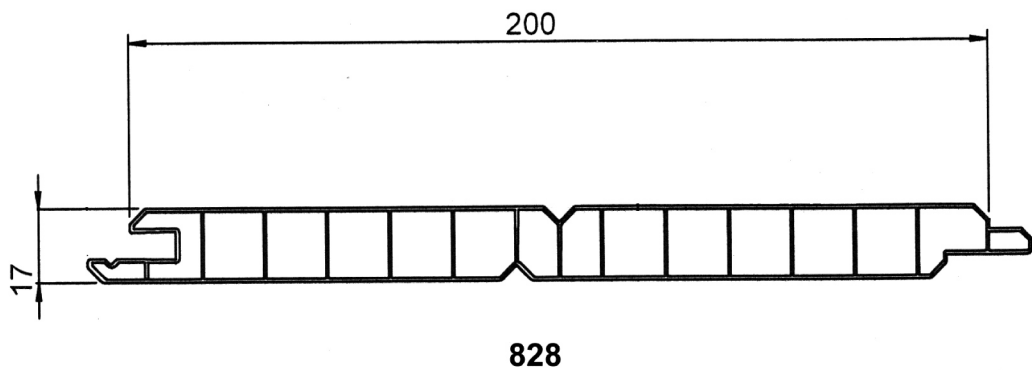
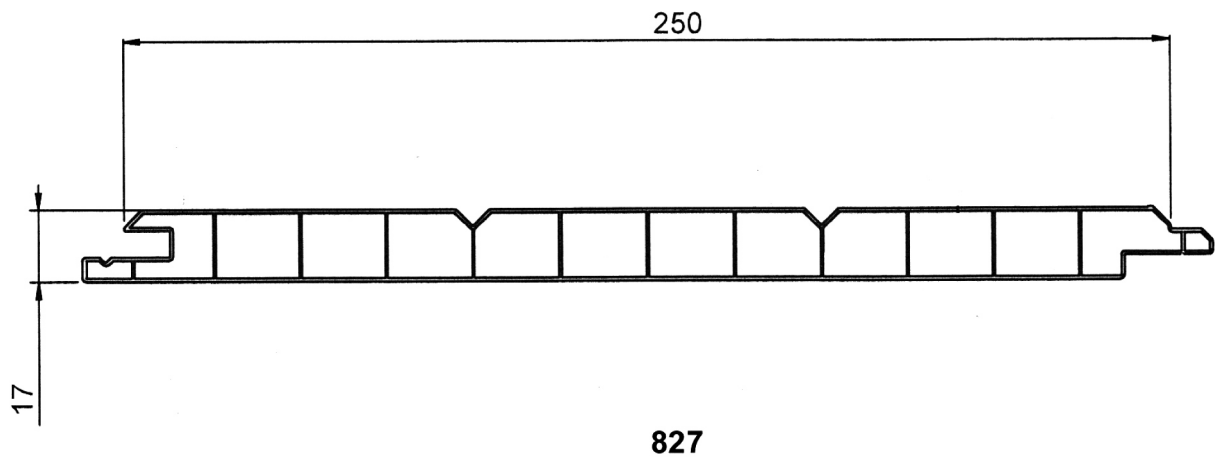



Verkleidungsprofile

Panel sections

Nut und Feder

Groove and tongue

Art.-Nr. Cat. - No.	Verkleidungsprofile Panel sections	Packung / lfm. Package / mtr.	Ausführung Execution	Lieferung Delivery
827	250 x 17 mm	30	○	
828	200 x 17 mm	30	○	

Sonder- u. Verkleidungsprofile
Special and panel solutions

Anwendungsbeispiel

Example

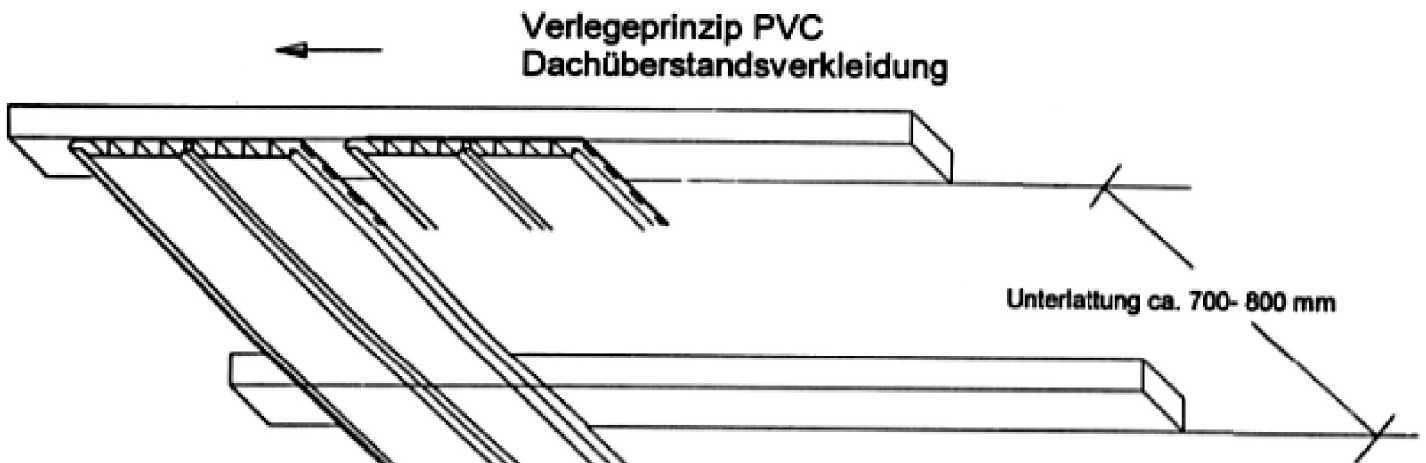

Montagehinweise:

Die Montage der Profile erfolgt auf einer Holzunterkonstruktion mit einer minimalen Holzstärke von 25 mm und einer Mindestbreite von 30 mm. Der Lattenabstand muss so eingehalten werden, dass die Verkleidungspaneele im Bereich der Dachüberstände (Auf-Sparren-Deckung & Unterverkleidung) mindestens alle 80 cm befestigt werden können, bei farbigen Paneelen mindestens alle 50 cm. Im Bereich der Fassade muss der Lattenabstand so eingehalten werden, dass die Verkleidungspaneele mindestens alle 30 cm befestigt werden können.

Farbige Paneele an der Fassade: Lattenabstand max. 30 cm und Verarbeitungslänge dieser Paneele max. 300 cm.

An jedem Paneelende ist ein Dehnabstand von mindestens 8 mm einzuhalten. Die Schutzfolie der Paneele direkt nach der Montage jedes Paneels entfernen. Eine Belüftung der Unterkonstruktion ist zwingend notwendig.