

Deckleisten für Dichtbänder und Cover strips for sealing strips and **Kompriband (Klebefestigung)** compression strip (adhesive mounting)

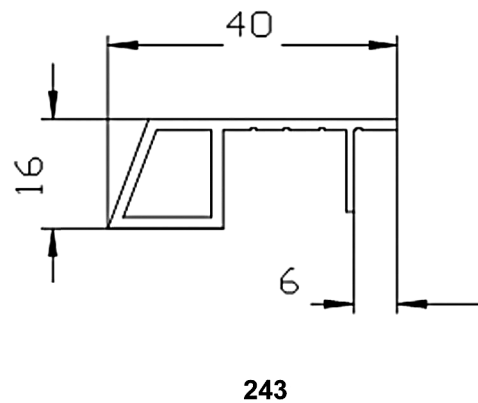
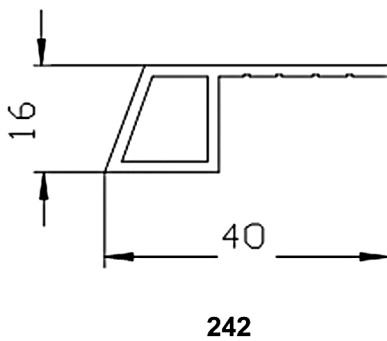
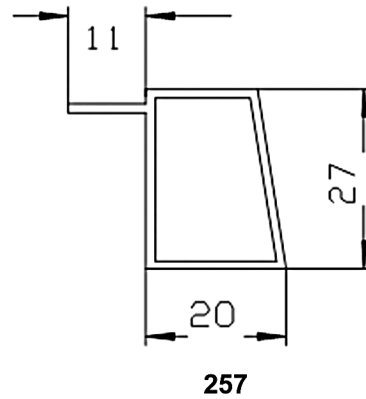
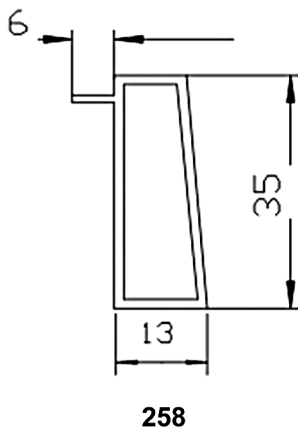
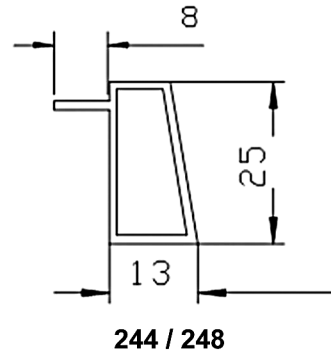
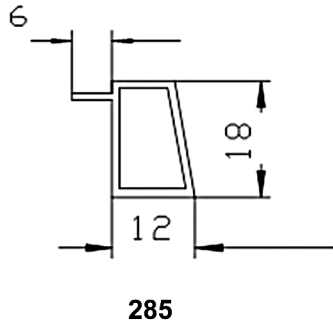

Deckleisten für Dichtbänder und Cover strips for sealing strips and Kompriband (Klebefestigung) compression strip (adhesive mounting)

Art.-Nr. Cat.-No.	Deckleisten Cover strips	Packung / lfm. Package / mtr.	Ausführung Execution	Lieferung Delivery
285	18 × 18 / 6 mm	90	○	
285	18 × 18 / 6 mm	90	○ SKS	
244	21 × 25 / 8 mm	30	○	
244	21 × 25 / 8 mm	60	● D	
248	21 × 25 / 8 mm	60	○ SKS	
258	19 × 35 / 6 mm	90	○	
258	19 × 35 / 6 mm	30	● D	
258	19 × 35 / 6 mm	90	○ SKS	
257	31 × 27 / 11 mm	60	○	
257	31 × 27 / 11 mm	60	○ SKS	
242	40 × 16	60	○	
243	40 × 16	60	○	
243	40 × 16	60	○ SKS	

- Schaumklebeband weiß (SKS 1 mm)
- Fugenraum siehe linke Seite
- foamed adhesive tape white (SKS 1 mm)
- for joint dimensions see left

Deckleisten für Dichtbänder und Cover strips for sealing strips and Kompriband (Clipsbefestigung) compression strip (clip mounting)

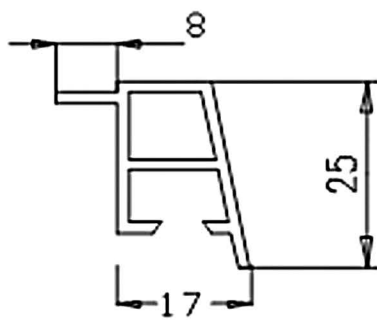

214

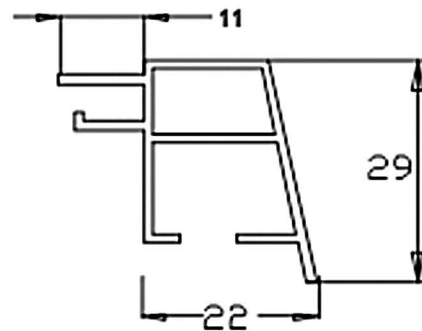

210

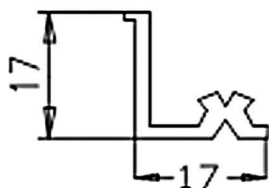

215

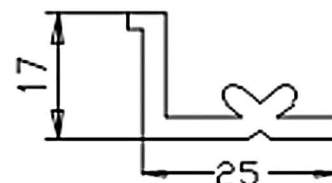

211

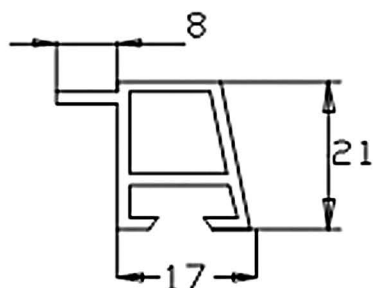



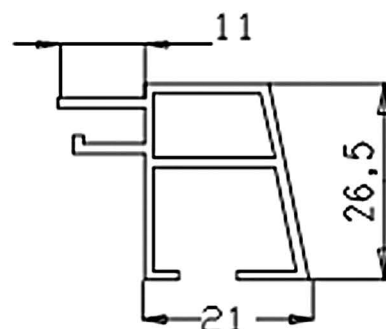









216



212

Deckleisten für Dichtbänder und Cover strips for sealing strips and Kompriband (Clipsbefestigung) compression strip (clip mounting)

Art.-Nr. Cat.-No.	Deckleisten Cover strips	Packung / lfm. Package / mtr.	Ausführung Execution	Lieferung Delivery
214	25 x 25 / 8 mm	120		
215	Unterbau 214	120		
210	33 x 29 / 11 mm	60		
211	Unterbau 210	60		
216	25 x 21 / 8 mm	120		
212	32 x 26,5 / 11 mm	60		
605	Schraubnippel / Screwed nipple	1000 Stk./pcs.		

210–216

- Fugenraum siehe oben
- zur Verwendung für Illmod Dichtungen
- für Verwendung auf Unterkonstruktionen (214, 210)
- zur Nippelbefestigung Typ 605 (216, 212)
- zur Schraubbefestigung (215, 211)

- for joint dimensions see above
- for Illmod sealings
- for substructures (214, 210)
- for nipple fastening, type 605 (216, 212)
- for screw fastening (215, 211)

Deckleisten für außen

Cover strips for outside mounting

mit vorgerüstetem Kompriband

with mounted compression strip

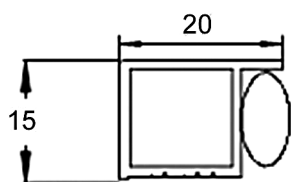

217 Ka

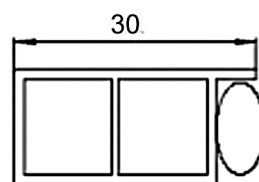

218 Ka

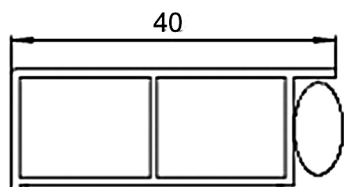

219 Ka

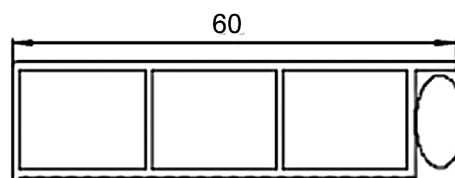

264 Ka

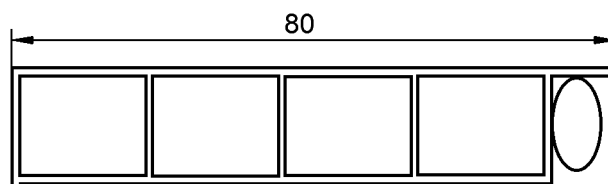

269 Ka

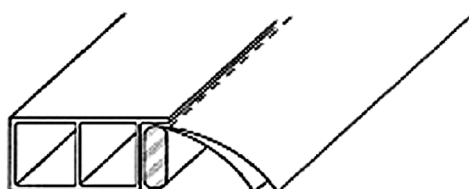











Lieferform der Profile

Deckleisten für außen

Cover strips for outside mounting

mit vorgerüstetem Kompriband

with mounted compression strip

Art.-Nr. Cat.-No.	Deckleisten Cover strips	Packung / lfm. Package / mtr.	Ausführung Execution	Lieferung Delivery
217 Ka	20 x 15 mm	60		
218 Ka	30 x 15 mm	60		
219 Ka	40 x 15 mm	60		
264 Ka	60 x 15 mm	60		
269 Ka	80 x 15 mm	60		

217 Ka – 269 Ka

- schlagregendicht
- diffusionsoffen
- Verklebung mit Kaltschweißkleber
- mit Illmod eco vorgerüstet Lieferlänge Art. 217 Ka – 269 Ka 6 m

- resistant to driving rain
- open for diffusion
- bonding with cold-setting adhesive
- delivered provided with Illmod, type eco
- Delivered length Art. 217 Ka – 269 Ka 6 m

Deckleisten für innen

Cover strips for inside mounting

mit vorgerüstetem Kompriband

with mounted compression strip

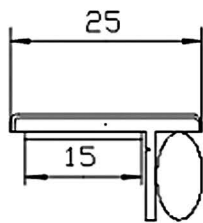

551

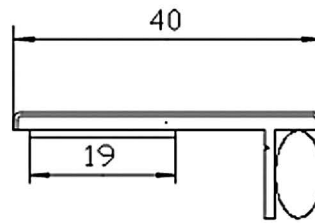

552

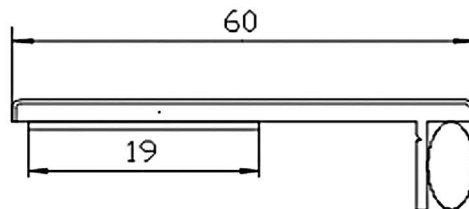

553

Anwendungsbeispiel

Example

Lieferlänge 5 / 6 Meter

Wärmedämmung
(Schaum)

innen

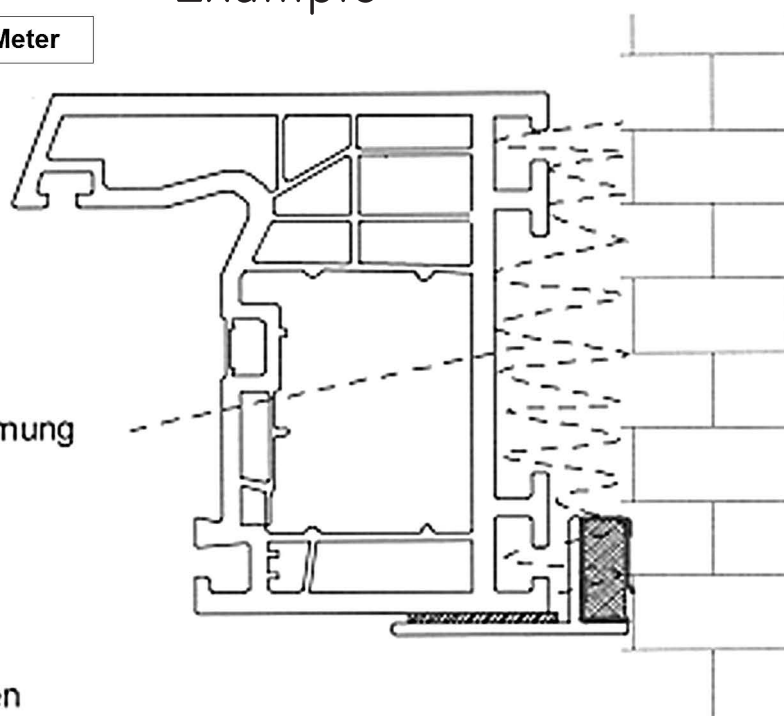







Deckleisten für innen

Cover strips for inside mounting

mit vorgerüstetem Kompriband

with mounted compression strip

Art.-Nr. Cat.-No.	Deckleisten Cover strips	Packung / lfm. Package / mtr.	Ausführung Execution	Lieferung Delivery
551	25 x 15 mm	60		
552	40 x 15 mm	60		
553	60 x 15 mm	50		

- schaumklebeband weiß (SKS 1 mm)
- mit Dampfsperre
- Kompriband umhüllt mit Polypropylen – Folie als Dampfsperre
- foamed adhesive tape white (SKS 1 mm)
- with vapour barrier
- compression strip enveloped in polypropylene – vapour barrier foil

Deckleisten für innen

Cover strips for inside mounting

mit vorgerüstetem Kompriband

with mounted compression strip

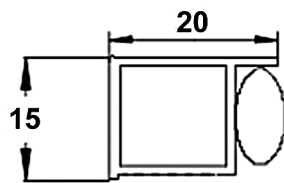

217 i

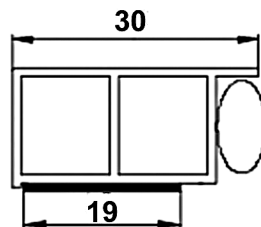

218 i

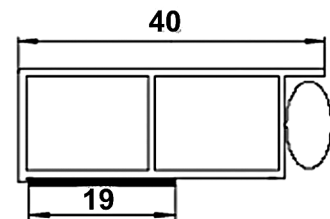

219 i

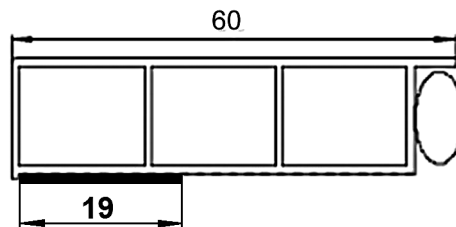

264 i

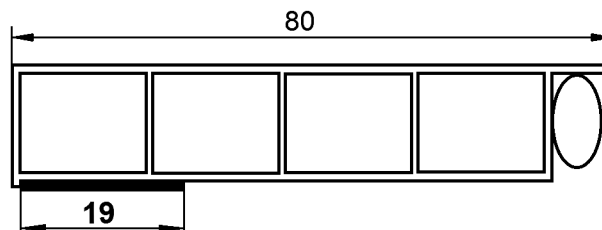

269 i

Nach der Montage wird die Diffusionsdichte Folienummantelung des Schaumes abgerissen. Durch die perforierte Foliennaht ist dies sehr leicht möglich. Dadurch drückt der Schaum die verbleibende Folie an das Mauerwerk. Hierdurch entsteht ein diffusionsdichter Mauerwerksabschluss entsprechend der RAL - Montagerichtlinien.

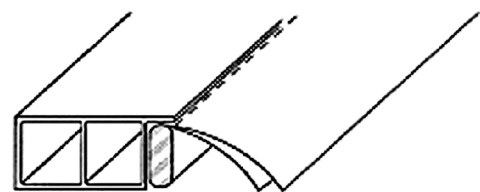





















Lieferform der Profile

Deckleisten für innen

Cover strips for inside mounting

mit vorgerüstetem Kompriband

with mounted compression strip

Art.-Nr. Cat.-No.	Deckleisten Cover strips	Packung / lfm. Package / mtr.	Ausführung Execution	Lieferung Delivery
217 i	20 x 15 mm	60		
218 i	30 x 15 mm	60		
219 i	40 x 15 mm	60		
264 i	60 x 15 mm	60		
269 i	80 x 15 mm	30		
217 i	20 x 15 mm	60		
218i	30 x 15 mm	60		
219i	40 x 15 mm	60		
264i	60 x 15 mm	60		
269i	80 x 15 mm	60		

Technische Daten

- Verträglichkeit mit herkömmlichen Baustoffen:
- Folie:
- Dicke der Folie:
- Dichtband:
- Luftdichtigkeit:
- Verarbeitungstemperatur:
- Temperaturbeständigkeit:
- Lagerfähigkeit:

- schaumklebeband weiß
- mit Dampfsperre
- Kompriband umhüllt mit Polypropylen – Folie als Dampfsperre

Technical data

- Compatibility with conventional building materials:
- Film:
- Film thickness:
- Sealing tape:
- Air tightness:
- Processing temperature:
- Temperature resistance:

- foamed adhesive tape white
- with vapour barrier
- compression strip enveloped in polypropylene – vapour barrier foil

Klassifizierung

gegeben
 Polypropylen
 30 µm
 PU-Weichschaum mit Acrylatimprägnat
 a-Wert 0,02 bei 9 mm Fugenbreite
 temperaturunabhängig durch nachträgliche Aktivierung
 –30°C bis +90°C
 2 Jahre

Classification

given
 polypropylene
 30 µm
 PU soft foam with acrylate impregnation
 a-value 0.02 at 9 mm joint width
 temperature-independent due to subsequent activation
 –30°C to +90°C • Shelf life: 2 years

Deckleisten für innen

Cover strips for inside mounting

mit vorgerüstetem Kompriband

with mounted compression strip

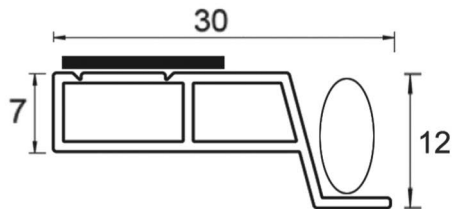

843

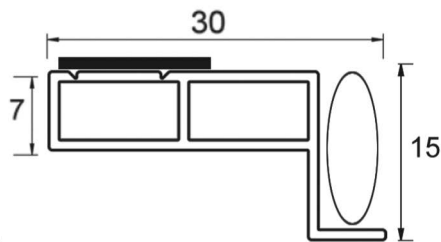









844

Deckleisten für innen

Cover strips for inside mounting

mit vorgerüstetem Kompriband

with mounted compression strip

Art.-Nr. Cat.-No.	Deckleisten Cover strips	Packung / lfm. Package / mtr.	Ausführung Execution	Lieferung Delivery
843 Ki	30 × 7 × 12 mm	60		
844 Ki	30 × 7 × 15 mm	60		
843 Ki	30 × 7 × 12 mm	60		
844 Ki	30 × 7 × 15 mm	60		
605	Schraubnippel	1000 Stk./pcs.		

Deckleisten mit vorgerüstetem Kompriband

Cover strips with mounted compression strip

Anwendungsbeispiel

Example

