

# Hohlkammerleisten

Cavity strips

mit Nase 7 mm dick

with nose, 7 mm thick

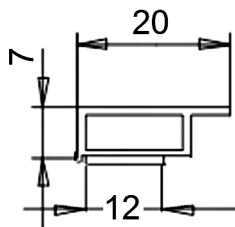

201

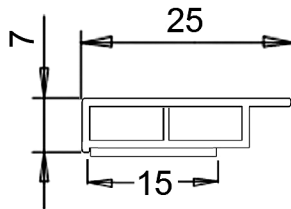

249

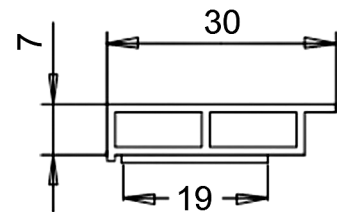

202

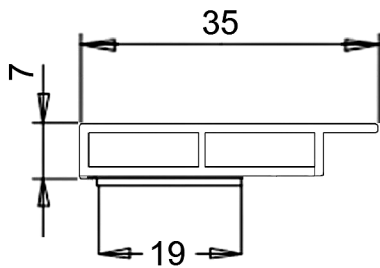

256

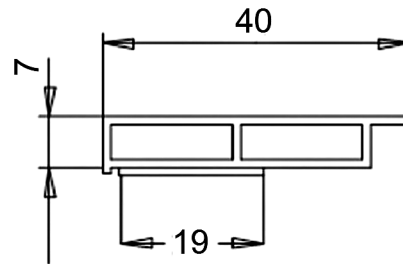





























203

# Hohlkammerleisten

Cavity strips

mit Nase 7 mm dick

with nose, 7 mm thick

Art.-Nr. Cat.-No.	Hohlkammerleisten Cavity strips	Packung / lfm. Package / mtr.	Ausführung Execution	Lieferung Delivery
201	20 × 7 mm	240		
201	20 × 7 mm	240		
201	20 × 7 mm	30		
201	20 × 7 mm	30		
249	25 × 7 mm	180		
202	30 × 7 mm	180		
202	30 × 7 mm	180		
202	30 × 7 mm	30		
202	30 × 7 mm	30		
256	35 × 7 mm	150		
203	40 × 7 mm	120		
203	40 × 7 mm	120		
203	40 × 7 mm	30		
203	40 × 7 mm	30		

- Schaumklebeband (SKS 1 mm)
- Dekoroberflächen – Lieferung auf Anfrage – keine Bevorratung.
- Bitte immer vollständige Folien-Nr. bei der Anfrage angeben!

- foamed adhesive tape (SKS 1 mm)
- Decorative surfaces – delivery on request – no stocking.
- Please always specify complete foil number with your inquiry!

# Hohlkammerleisten

Cavity strips

mit Nase 7 mm dick

with nose, 7 mm thick

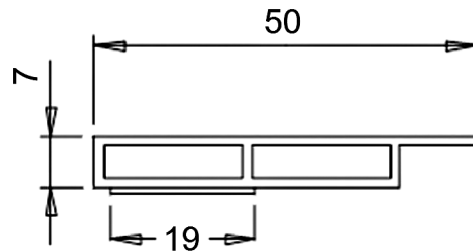

247

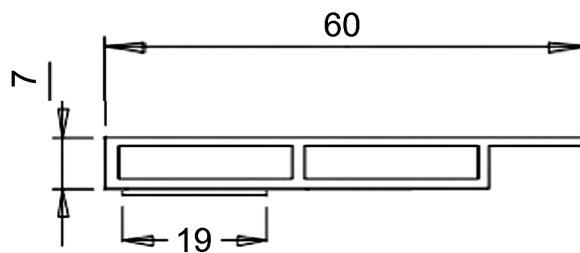

234

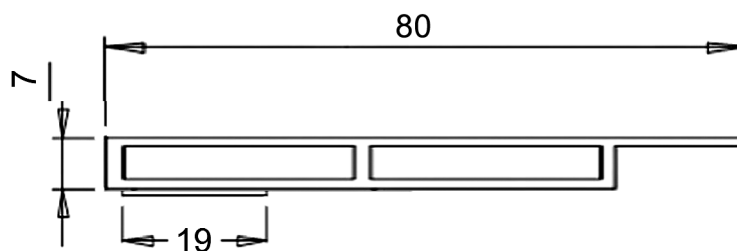

















298

# Hohlkammerleisten

Cavity strips

mit Nase 7 mm dick

with nose, 7 mm thick

Art.-Nr. Cat.-No.	Hohlkammerleisten Cavity strips	Packung / lfm. Package / mtr.	Ausführung Execution	Lieferung Delivery
247	50 x 7 mm	90		
247	50 x 7 mm	90		
247	50 x 7 mm	30		
247	50 x 7 mm	30		
234	60 x 7 mm	60		
234	60 x 7 mm	60		
298	80 x 7 mm	60		
298	80 x 7 mm	60		

- Schaumklebeband (SKS 1 mm)
- Dekoroberflächen – Lieferung auf Anfrage – keine Bevorratung.
- Bitte immer vollständige Folien-Nr. bei der Anfrage angeben!

- foamed adhesive tape (SKS 1 mm)
- Decorative surfaces – delivery on request – no stocking.
- Please always specify complete foil number with your inquiry!

# Hohlkammerleisten

Cavity strips

**ohne Nase 7 mm dick**

without nose, 7 mm thick

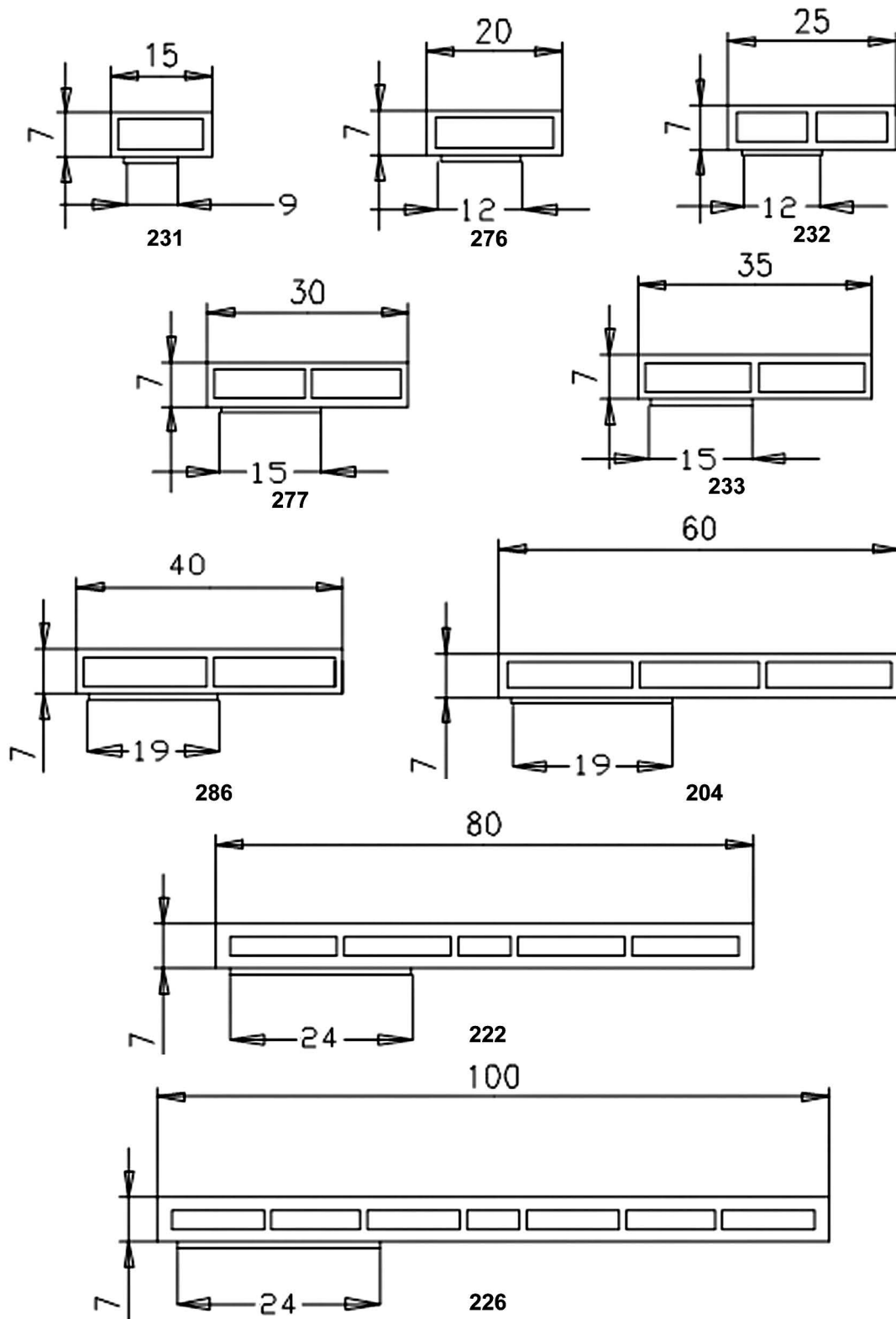



















# Hohlkammerleisten

Cavity strips

**ohne Nase 7 mm dick**

without nose, 7 mm thick

Art.-Nr. Cat.-No.	Hohlkammerleisten Cavity strips	Packung / lfm. Package / mtr.	Ausführung Execution	Lieferung Delivery
231	15 x 7 mm	240	○	
231	15 x 7 mm	240	○ SKS	
276	20 x 7 mm	180	○	
276	20 x 7 mm	180	○ SKS	
232	25 x 7 mm	180	○	
232	25 x 7 mm	180	○ SKS	
277	30 x 7 mm	120	○	
277	30 x 7 mm	120	○ SKS	
233	35 x 7 mm	120	○	
233	35 x 7 mm	120	○ SKS	
286	40 x 7 mm	90	○	
286	40 x 7 mm	90	○ SKS	
204	60 x 7 mm	60	○	
204	60 x 7 mm	60	○ SKS	
222	80 x 7 mm	60	○	
222	80 x 7 mm	60	○ SKS	
226	100 x 7 mm	60	○	
226	100 x 7 mm	60	○ SKS	

- Schaumklebeband (SKS 1 mm)
- foamed adhesive tape (SKS 1 mm)

# Hohlkammerleisten

Cavity strips

**7 mm dick**

7 mm thick

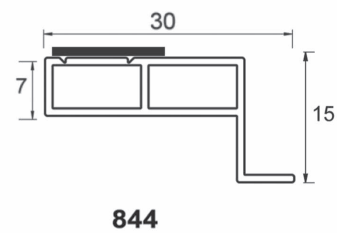
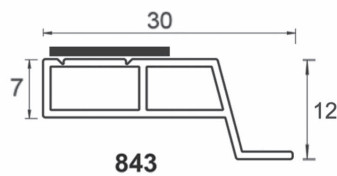
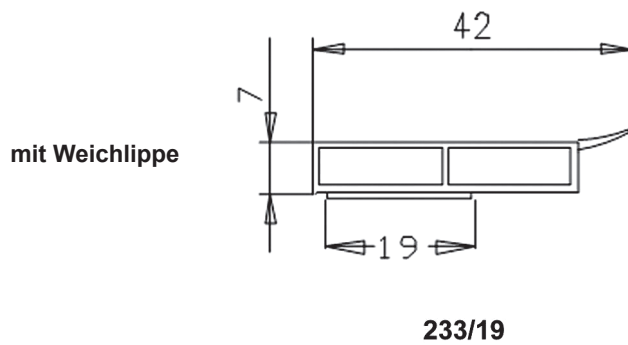
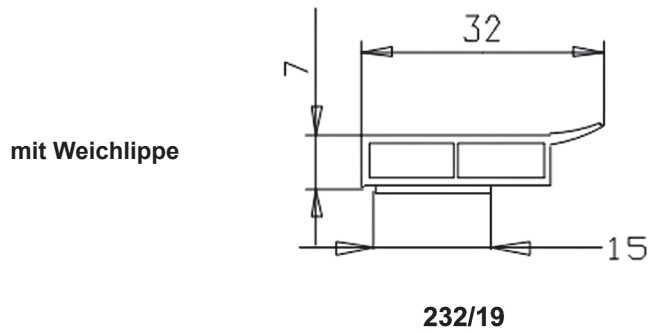













# Hohlkammerleisten

Cavity strips

**7 mm dick**

7 mm thick

Art.-Nr. Cat.-No.	Hohlkammerleisten Cavity strips	Packung / lfm. Package / mtr.	Ausführung Execution	Lieferung Delivery
232/19	32 x 7 mm	90		
233/19	42 x 7 mm	90		
843	30 x 7 mm	60		
844	30 x 7 mm	60		
843	30 x 7 mm	60		
844	30 x 7 mm	60		

- Schaumklebeband (SKS 1 mm)
- Weichlippen weiß
- Lippenlänge ca. 7 mm
- foamed adhesive tape (SKS 1 mm)
- soft lips white
- lip length approx. 7 mm

# Hohlkammerleisten

Cavity strips

mit Nase 15 mm dick

with nose, 15 mm thick

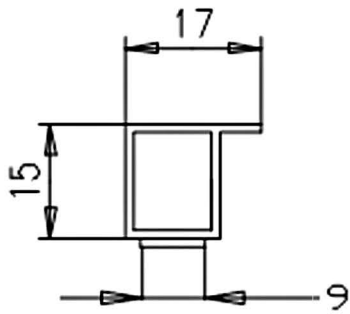

217

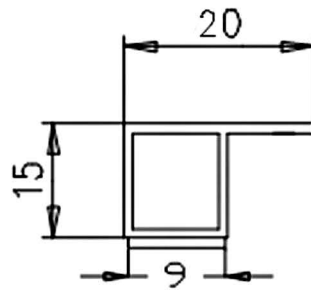

2172215

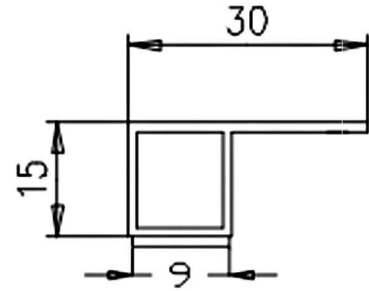

218LN

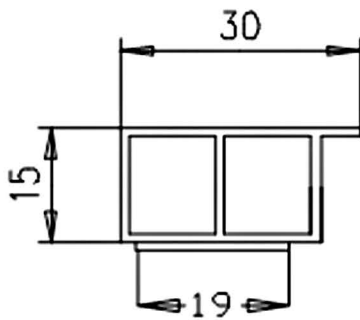

218

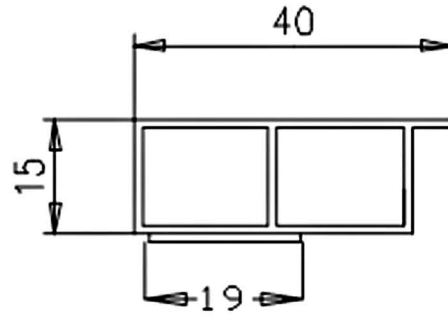

219

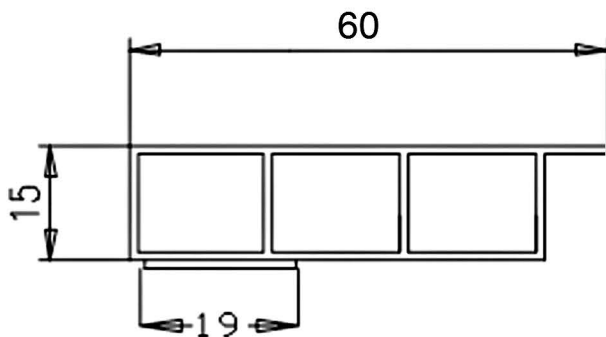

264

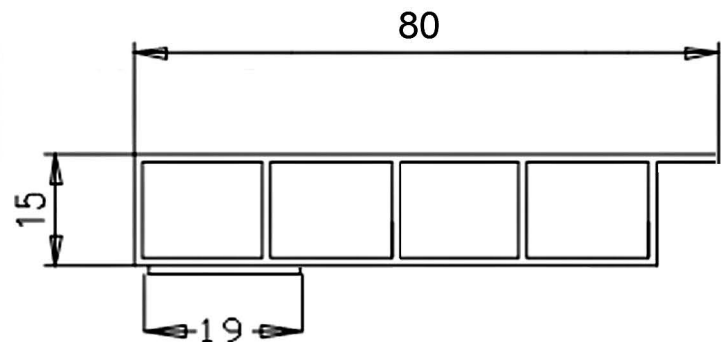

269

# Hohlkammerleisten

Cavity strips

mit Nase 15 mm dick

with nose, 15 mm thick

Art.-Nr. Cat.-No.	Hohlkammerleisten Cavity strips	Packung / lfm. Package / mtr.	Ausführung Execution	Lieferung Delivery
217	17 x 15 mm	180	○	
217	17 x 15 mm	180	○ SKS	
2172015	20 x 15 mm	180	○	
2172215	20 x 15 mm	180	○ SKS	
2172015	20 x 15 mm	30	● D	
2172215	20 x 15 mm	30	● D SKS	
218	30 x 15 mm	120	○	
218	30 x 15 mm	120	○ SKS	
218	30 x 15 mm	30	● D	
218	30 x 15 mm	30	● D SKS	
219	40 x 15 mm	90	○	
219	40 x 15 mm	90	○ SKS	
219	40 x 15 mm	30	● D	
219	40 x 15 mm	30	● D SKS	
264	60 x 15 mm	60	○	
264	60 x 15 mm	60	○ SKS	
218 LN	30 x 15 mm	120	○	
218 LN	30 x 15 mm	120	○ SKS	
269	80 x 15 mm	30	○	
269	80 x 15 mm	30	○ SKS	

- Schaumklebeband (SKS 1 mm)
- Dekoroberflächen – Lieferung auf Anfrage – keine Bevorratung.
- Bitte immer vollständige Folien-Nr. bei der Anfrage angeben!

- foamed adhesive tape (SKS 1 mm)
- Decorative surfaces – delivery on request – no stocking.
- Please always specify complete foil number with your inquiry!

# Hohlkammerleisten

Cavity strips



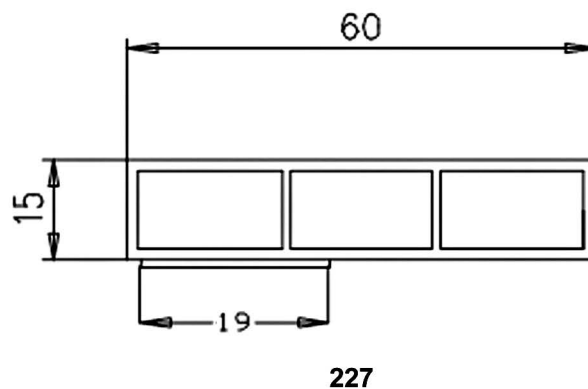
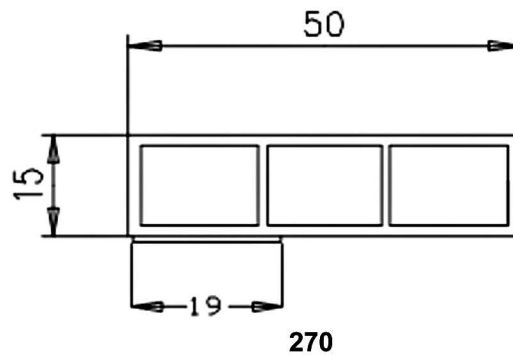
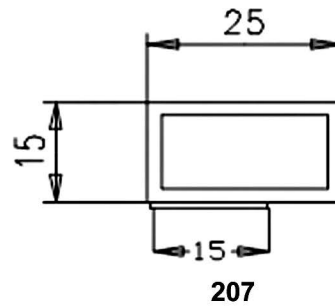
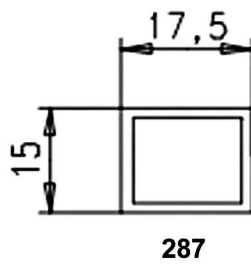











**ohne Nase 15 mm dick**  
without nose, 15 mm thick



# Hohlkammerleisten

Cavity strips

**ohne Nase 15 mm dick**  
without nose, 15 mm thick

Art.-Nr. Cat.-No.	Hohlkammerleisten Cavity strips	Packung / lfm. Package / mtr.	Ausführung Execution	Lieferung Delivery
287	15 x 17,5 x 2 mm	60		
207	25 x 15 mm	90		
207	25 x 15 mm	90		
270	50 x 15 mm	60		
270	50 x 15 mm	60		
227	60 x 15 mm	60		
227	60 x 15 mm	60		

- Schaumklebeband (SKS 1 mm)
- foamed adhesive tape (SKS 1 mm)

# Hohlkammerleisten

Cavity strips

**ohne Nase 15 mm dick**



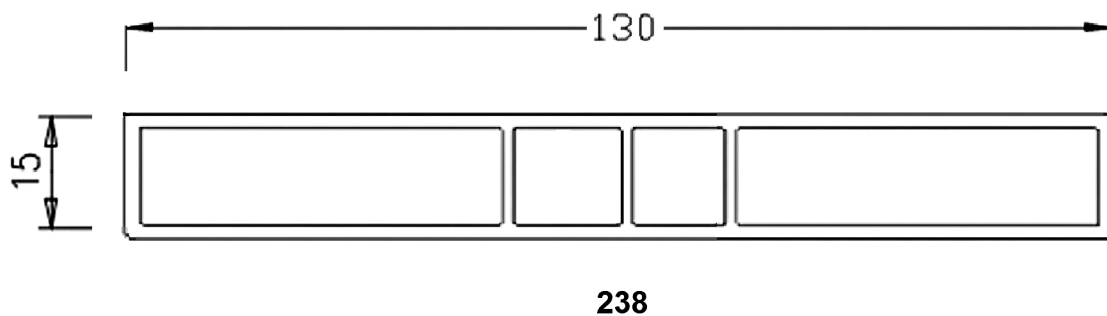
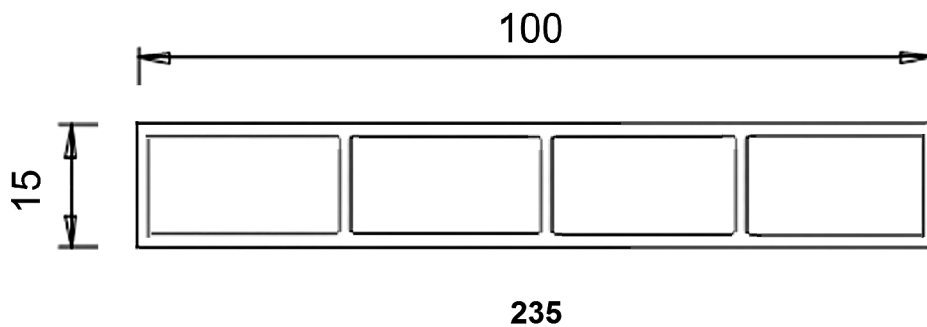
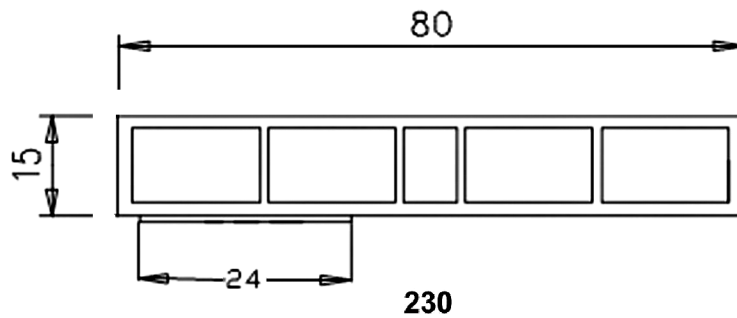



without nose, 15 mm thick



# Hohlkammerleisten

Cavity strips

**ohne Nase 15 mm dick**  
without nose, 15 mm thick

Art.-Nr. Cat.-No.	Hohlkammerleisten Cavity strips	Packung / lfm. Package / mtr.	Ausführung Execution	Lieferung Delivery
230	80 × 15 mm	30	○	
230	80 × 15 mm	30	○SKS	
235	100 × 15 mm	30	○	
235	100 × 15 mm	30	○SKS	
238	130 × 15 mm	30	○	
238	130 × 15 mm	30	○SKS	

Hohlkammerleisten  
Cavity strips

# Hohlkammerleisten

Cavity strips

## Vario-System Profile

Vario system – profiled strips

Patent DBP 43 25 611 C2

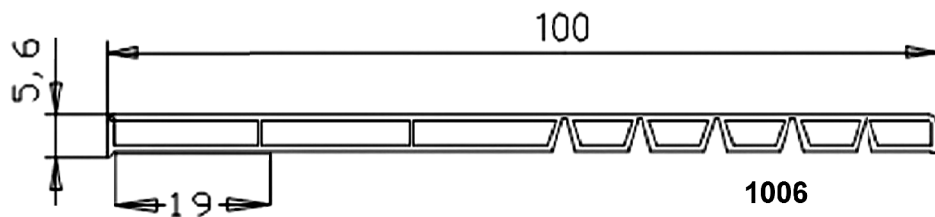
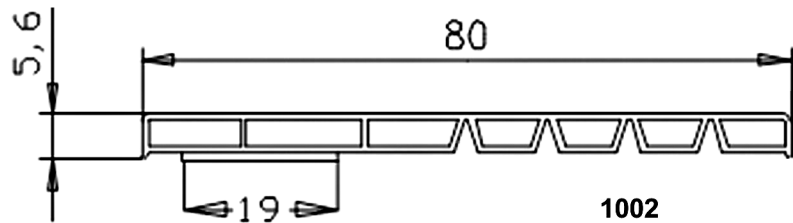
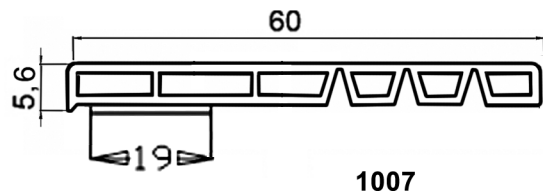
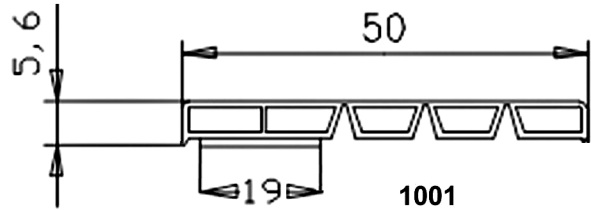
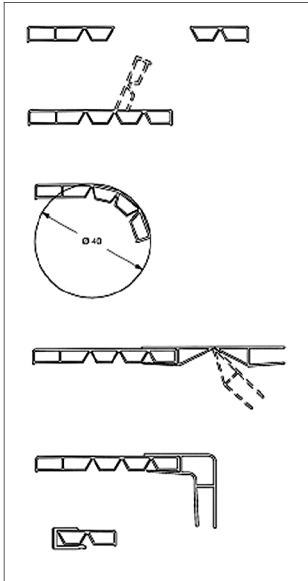

# Hohlkammerleisten

Cavity strips

## Vario-System Profile

Vario system – profiled strips

Art.-Nr. Cat.-No.	Hohlkammerleisten Cavity strips	Packung / lfm. Package / mtr.	Ausführung Execution	Lieferung Delivery
1001	20 - 50 x 5 mm	60	○	
1001	20 - 50 x 5 mm	60	○ SKS	
1001	20 - 50 x 5 mm	30	● D	
1001	20 - 50 x 5 mm	30	● D ○ SKS	
1007	30 - 60 x 5 mm	60	○	
1007	30 - 60 x 5 mm	60	○ SKS	
1007	30 - 60 x 5 mm	60	● D	
1007	30 - 60 x 5 mm	60	● D ○ SKS	
1002	40 - 80 x 5 mm	60	○	
1002	40 - 80 x 5 mm	60	○ SKS	
1002	40 - 80 x 5 mm	30	● D	
1002	40 - 80 x 5 mm	30	● D ○ SKS	
1006	50 - 100 x 5 mm	60	○	
1006	50 - 100 x 5 mm	60	○ SKS	
1006	50 - 100 x 5 mm	30	● D	
1006	50 - 100 x 5 mm	30	● D ○ SKS	

- Dekoroberflächen – Lieferung auf Anfrage – keine Bevorratung.
- Bitte immer vollständige Folien-Nr. bei der Anfrage angeben!

- Decorative surfaces – delivery on request – no stocking.
- Please always specify complete foil number with your inquiry!

# Hohlkammerleisten

Cavity strips

## Vario-System Profile

Vario system – profiled strips

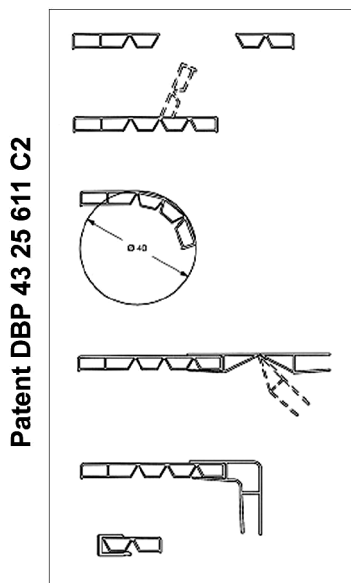
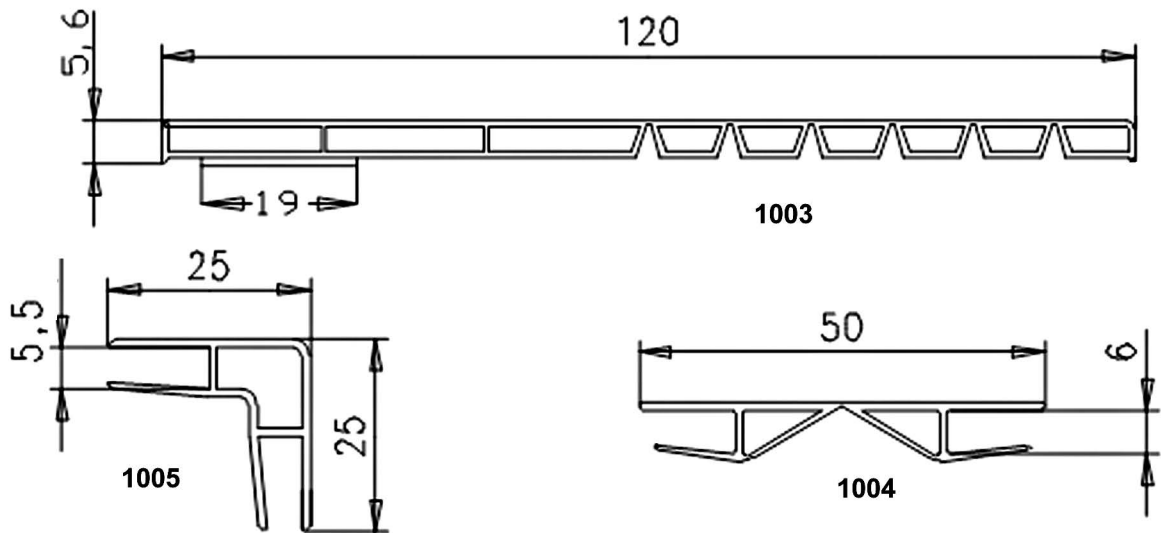







# Hohlkammerleisten

Cavity strips

## Vario-System Profile

Vario system – profiled strips

Art.-Nr. Cat.-No.	Hohlkammerleisten Cavity strips	Packung / lfm. Package / mtr.	Ausführung Execution	Lieferung Delivery
1003	60 - 120 x 5 mm	60	○	
1003	60 - 120 x 5 mm	60	○ SKS	
1003	60 - 120 x 5 mm	30	● D	
1003	60 - 120 x 5 mm	30	● D SKS	
1004	25 - 25 x 7 mm	60	○	
1004	25 - 25 x 7 mm	30	● D	
1005	25 - 25 x 7 mm	60	○	

- Dekoroberflächen – Lieferung auf Anfrage – keine Bevorratung.
- Bitte immer vollständige Folien-Nr. bei der Anfrage angeben!
- Decorative surfaces – delivery on request – no stocking.
- Please always specify complete foil number with your inquiry!

# Hohlkammerleisten

Cavity strips

## Rechteck-Rohrprofile

Rectangular tube strips

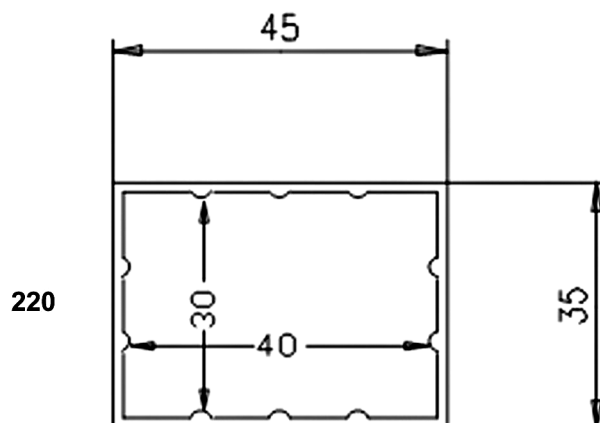
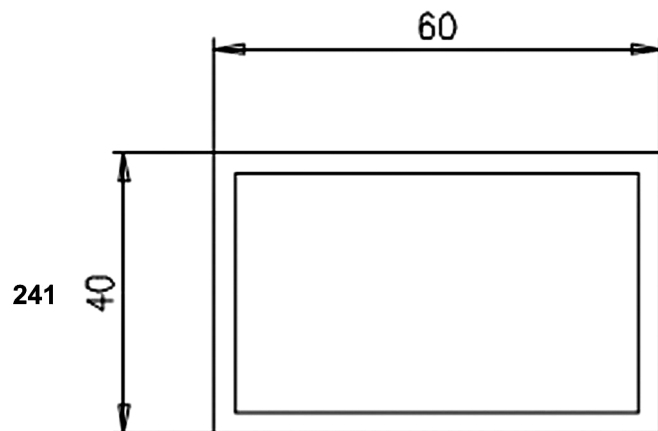
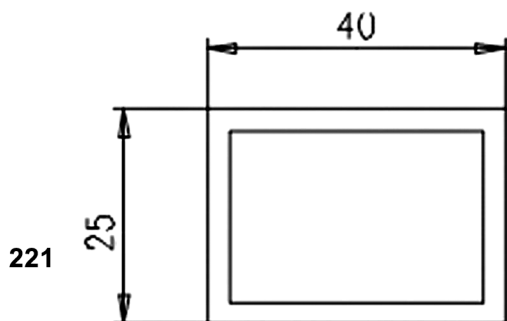
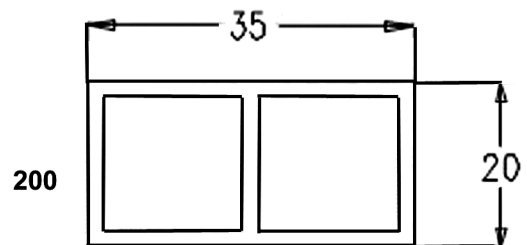
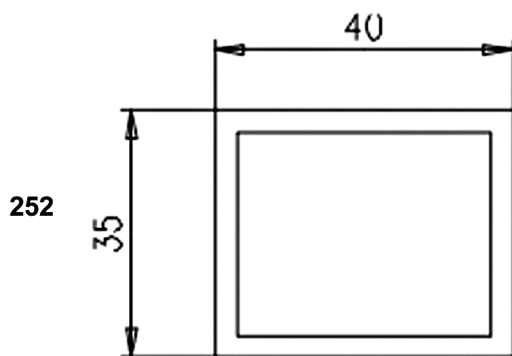
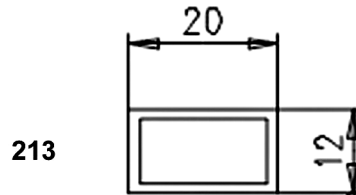







# Hohlkammerleisten

Cavity strips

## Rechteck-Rohrprofile

Rectangular tube strips

Art.-Nr. Cat.-No.	Hohlkammerleisten Cavity strips	Packung / lfm. Package / mtr.	Ausführung Execution	Lieferung Delivery
213	12 x 20 x 2 mm	120	○	
252	35 x 40 x 3 mm	30	○	
241	60 x 40 x 3 mm	30	○	
220	35 x 45 x 2 mm	30	○	
200	35 x 20 x 2 mm	60	○	
221	40 x 25 x 2 mm	60	○	

# Hohlkammerleisten

Cavity strips

## Rechteck-Rohrprofile

Rectangular tube strips

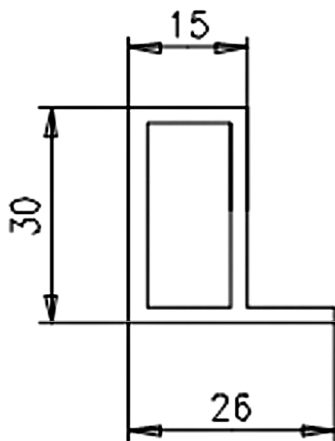

225

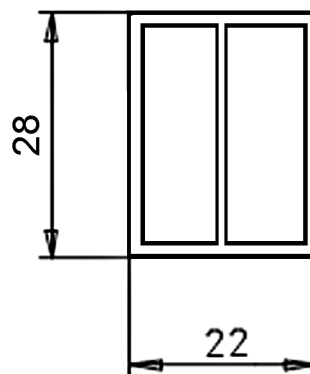

255

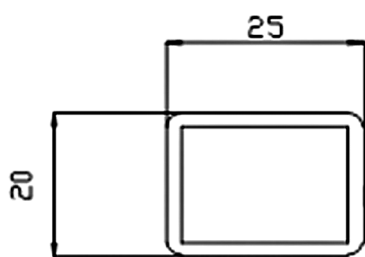

236

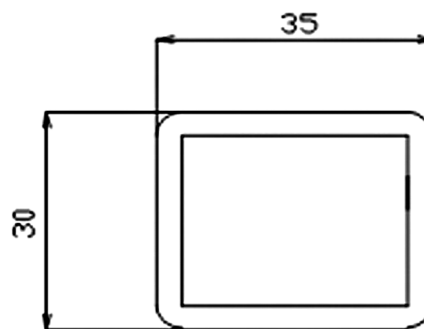

239

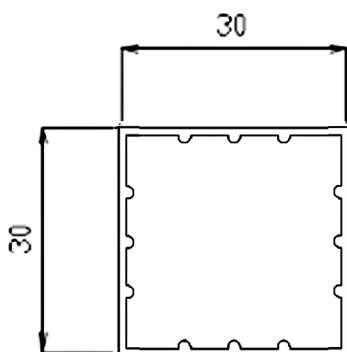

228

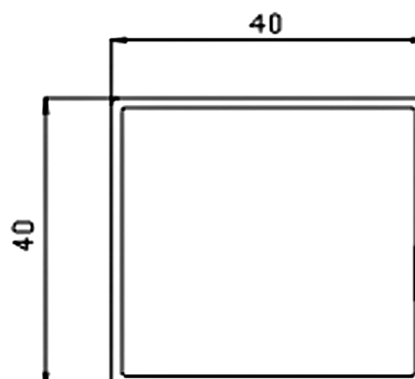







267

# Hohlkammerleisten

Cavity strips

## Rechteck-Rohrprofile

Rectangular tube strips

Art.-Nr. Cat.-No.	Hohlkammerleisten Cavity strips	Packung / lfm. Package / mtr.	Ausführung Execution	Lieferung Delivery
228	30 x 30 x 1,5 mm	60	○	
225	30 x 26 x 2 mm	60	○	
236	25 x 20 x 2 mm	60	○	
239	35 x 30 x 3,2 mm	60	○	
255	28 x 22 x 2 mm	60	○	
267	40 x 40 x 1,5 mm	60	○	

Hohlkammerleisten  
Cavity strips

# Hohlkammerleisten

Cavity strips

mit Nase

With nose

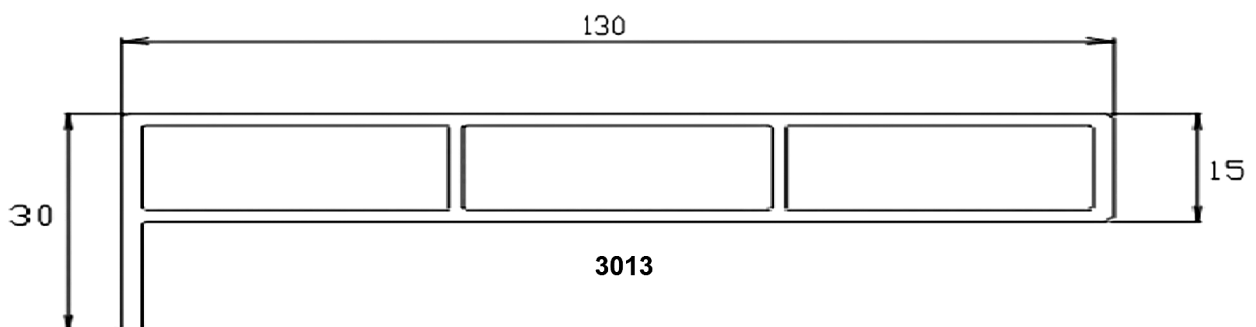
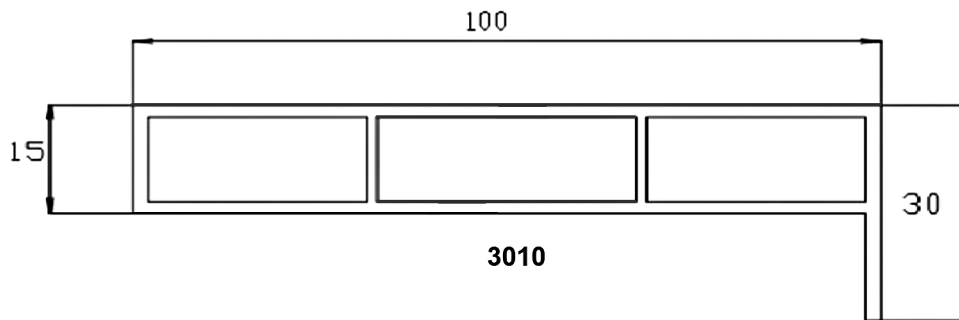
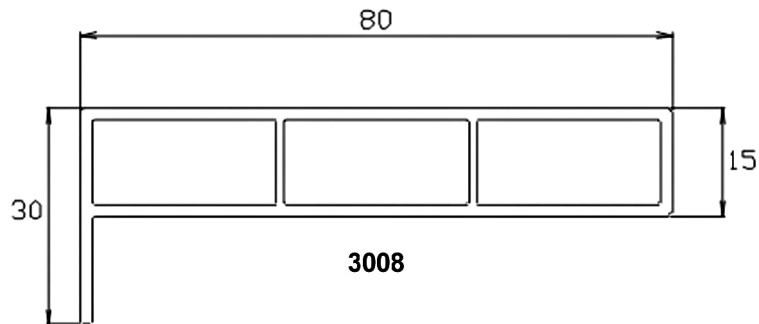
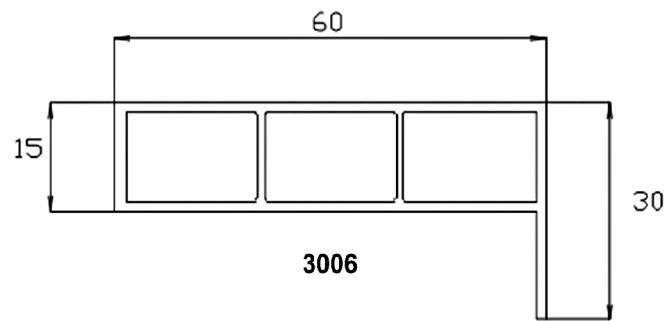





# Hohlkammerleisten

Cavity strips

**mit Nase**

With nose

---

Art.-Nr. Cat.-No.	Hohlkammerleisten Cavity strips	Packung / lfm. Package / mtr.	Ausführung Execution	Lieferung Delivery
3006	60 x 30 x 15 mm	30	○	
3008	80 x 30 x 15 mm	30	○	
3010	100 x 30 x 15 mm	30	○	
3013	130 x 30 x 15 mm	30	○	

Hohlkammerleisten  
Cavity strips

# Hohlkammerleisten

Cavity strips

## Sonderformen

Special shapes

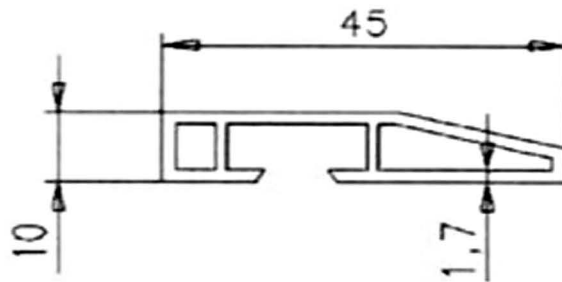

223

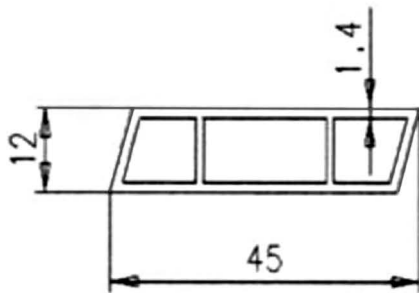

251

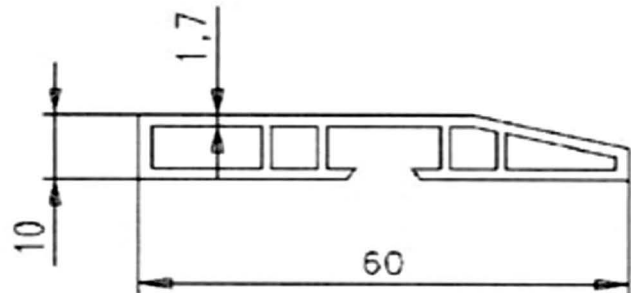

224

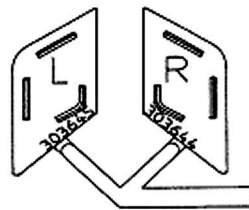

3646

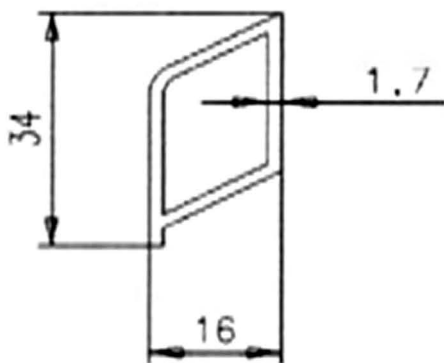

425

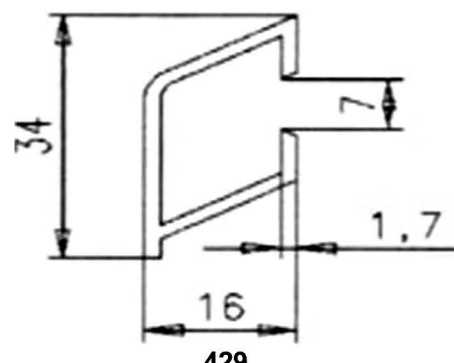











429

# Hohlkammerleisten

Cavity strips

## Sonderformen

Special shapes

Art.-Nr. Cat.-No.	Hohlkammerleisten Cavity strips	Packung / lfm. Package / mtr.	Ausführung Execution	Lieferung Delivery
251	45 × 12 mm	60	○	
251	45 × 12 mm	60	○ SKS	
223	45 × 10 mm Traverse	60	○	
224	60 × 10 mm Traverse	60	○	
425	16 × 34 mm Wetterschenkel	60	○	
425	16 × 34 mm Wetterschenkel	60	○ SKS	
425	16 × 34 mm Wetterschenkel	30	● D	
425	16 × 34 mm Wetterschenkel	30	● D SKS	
429	16 × 34 mm Wetterschenkel	60	○	
3646	Endkappen / End caps	100 Stk./pcs.	○	
3646	Endkappen / End caps	100 Stk./pcs.	●	

# Hohlkammerleisten

Cavity strips

## Sonderformen

Special shapes

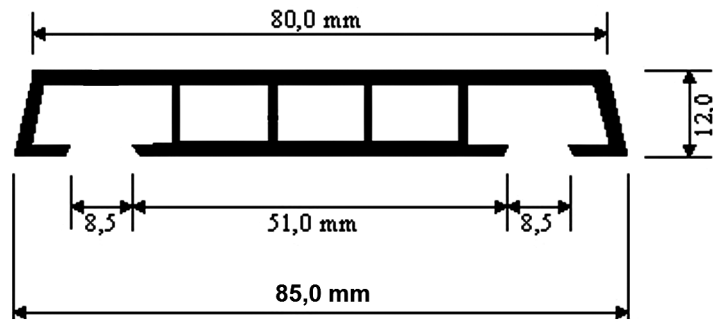

209

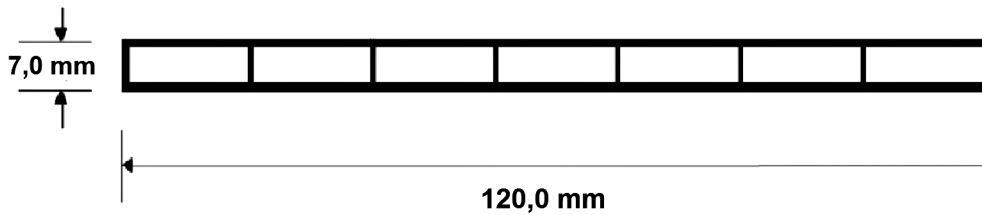

282

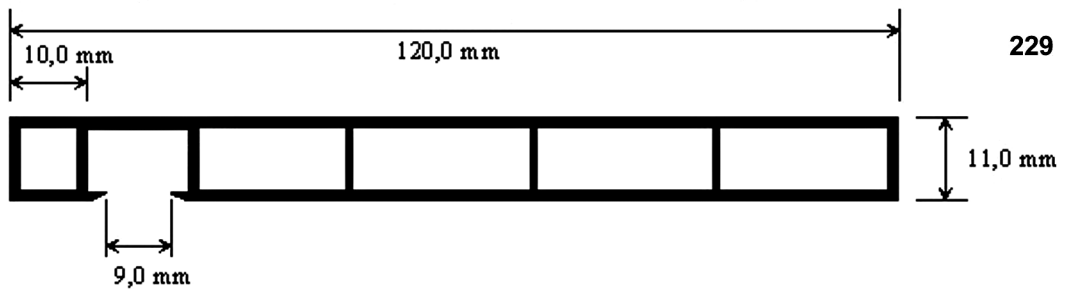

229

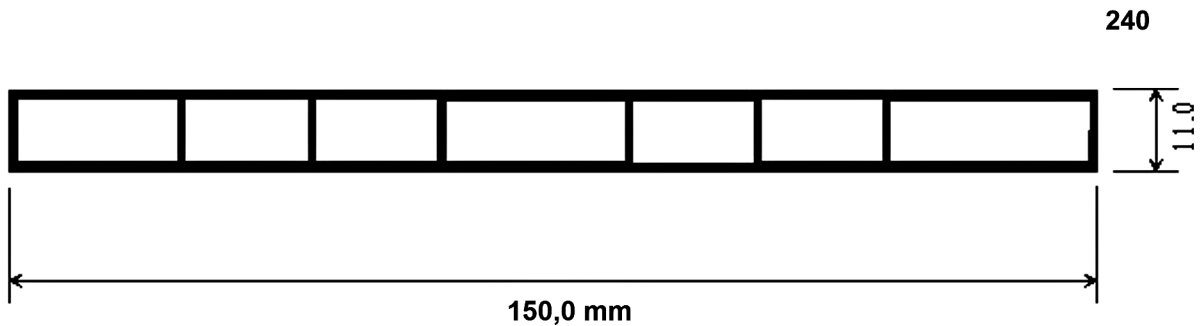











240

# Hohlkammerleisten

Cavity strips

## Sonderformen

Special shapes

Art.-Nr. Cat.-No.	Hohlkammerleisten Cavity strips	Packung / lfm. Package / mtr.	Ausführung Execution	Lieferung Delivery
209	85 x 12	60		
229	120 x 11	30		
240	150 x 11	30		
282	120 x 7	30		
282	120 x 7	30		
604	passende Schrauben für 209 und 229 (VE 500 Stk)			

# Hohlkammerleisten

Cavity strips

## Sonderformen

Special shapes

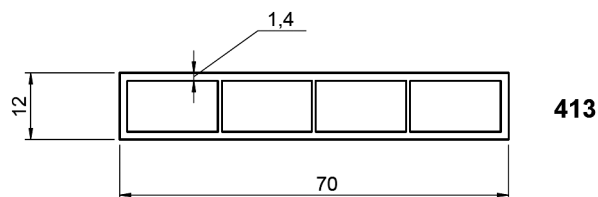
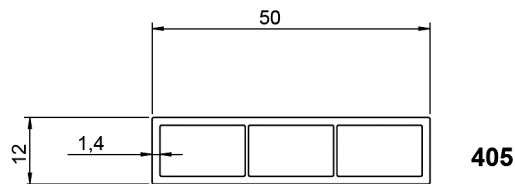
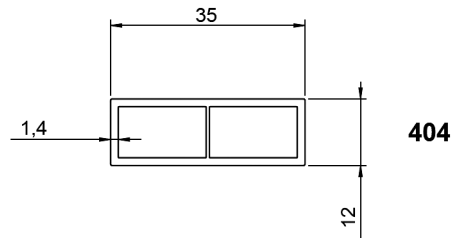



# Hohlkammerleisten

Cavity strips

## Sonderformen

Special shapes

---

Art.-Nr. Cat.-No.	Hohlkammerleisten Cavity strips	Packung / lfm. Package / mtr.	Ausführung Execution	Lieferung Delivery
404	35 x 12 mm	60	○	
405	50 x 12 mm	60	○	
413	70 x 12 mm	60	○	

# Hohlkammerleisten

Cavity strips

mit Nase 7 mm dick

with nose, 7 mm thick

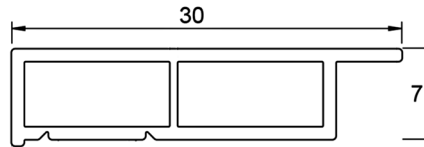

202 S

# Hohlkammerleisten

Cavity strips

**mit Nase 7 mm dick**

with nose, 7 mm thick

---

Art.-Nr. Cat. - No.	Hohlkammerleisten Cavity strips	Packung / lfm. Package / mtr.	Ausführung Execution	Lieferung Delivery
<b>202 S</b>	<b>30 x 7 mm</b>	<b>30</b>		
<b>605</b>	Schraubnippel / Screwed nipple	<b>1000 Stk./pcs.</b>		

---

Weitere Abmessungen in Planung.

Additional dimensions in planning

Hohlkammerleisten  
Cavity strips

# Hohlkammerleisten

Cavity strips

## Verwendungsarten des Vario-Profilsystems

Usage types of vario profil system

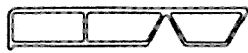

Anwendung 1  
Anpassung mit Cutter-Messer  
in 10 mm Schritten

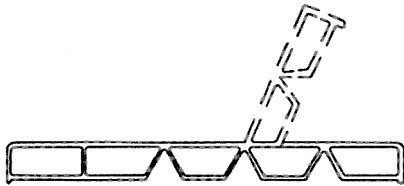

Anwendung 2  
Knickbar in beliebiger  
Winkelstellung

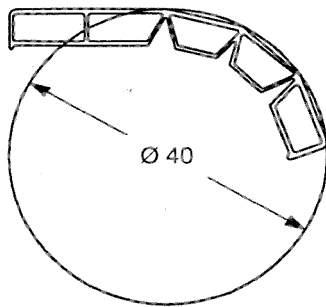

Anwendung 3  
Verrunden minimaler  
Biegekreis Durchmesser  
40mm / Winkelschnitt = 30mm

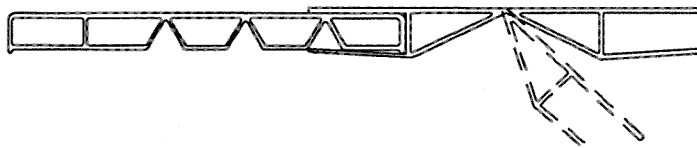

Anwendung 4  
Kombination mit Verbinder und  
beliebige Winkelstellung

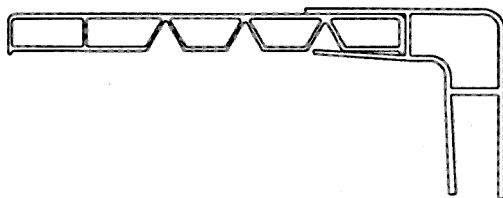

Anwendung 5  
90° Verbinder