

Winkelprofile geschäumt

Angles profiles, foamed

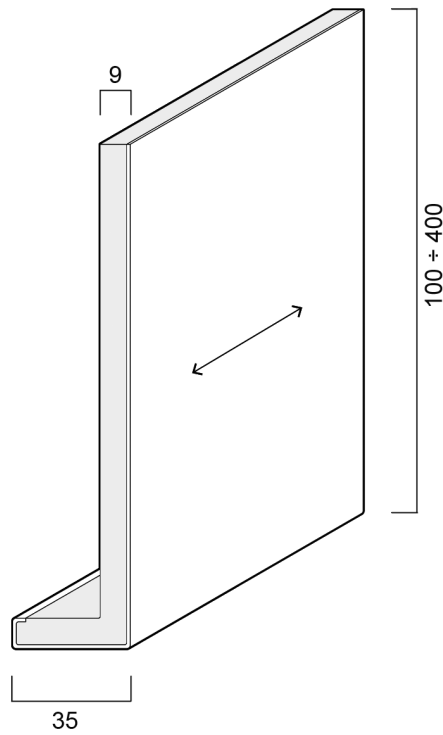

Außenecke
6036

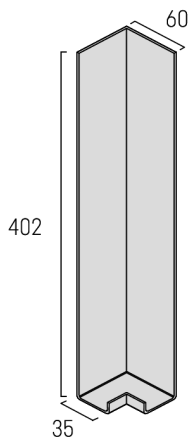

Innenecke
6037

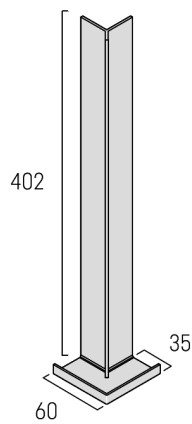

Verbinder
6038

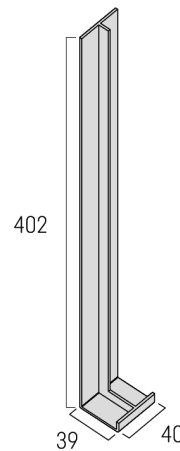



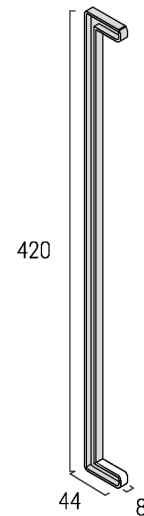









Endkappe
6039



Winkelprofile geschäumt

Angles profiles, foamed

Art.-Nr. Cat.-No.	Winkel Angles	Packung / lfm. Package / mtr.	Ausführung Execution	Lieferung Delivery
60351001	100 x 35 x 9	2 x 6 m	○	
60351501	150 x 35 x 9	2 x 6 m	○	
60351751	175 x 35 x 9	2 x 6 m	○	
60352001	200 x 35 x 9	2 x 6 m	○	
60352251	225 x 35 x 9	2 x 6 m	○	
60352501	250 x 35 x 9	2 x 6 m	○	
60353001	300 x 35 x 9	2 x 6 m	○	
60354001	400 x 35 x 9	2 x 6 m	○	
60360001	Außenecke	20 Stk.	○	
60370001	Innenecke	20 Stk.	○	
60380001	Verbinder	20 Stk.	○	
60390001	Endkappe	4 Stk.	○	

- Dekoroberflächen – Lieferung auf Anfrage.
- Decorative surfaces – available on request.

Winkel

Angles

gleichschenkelig

Equal angles

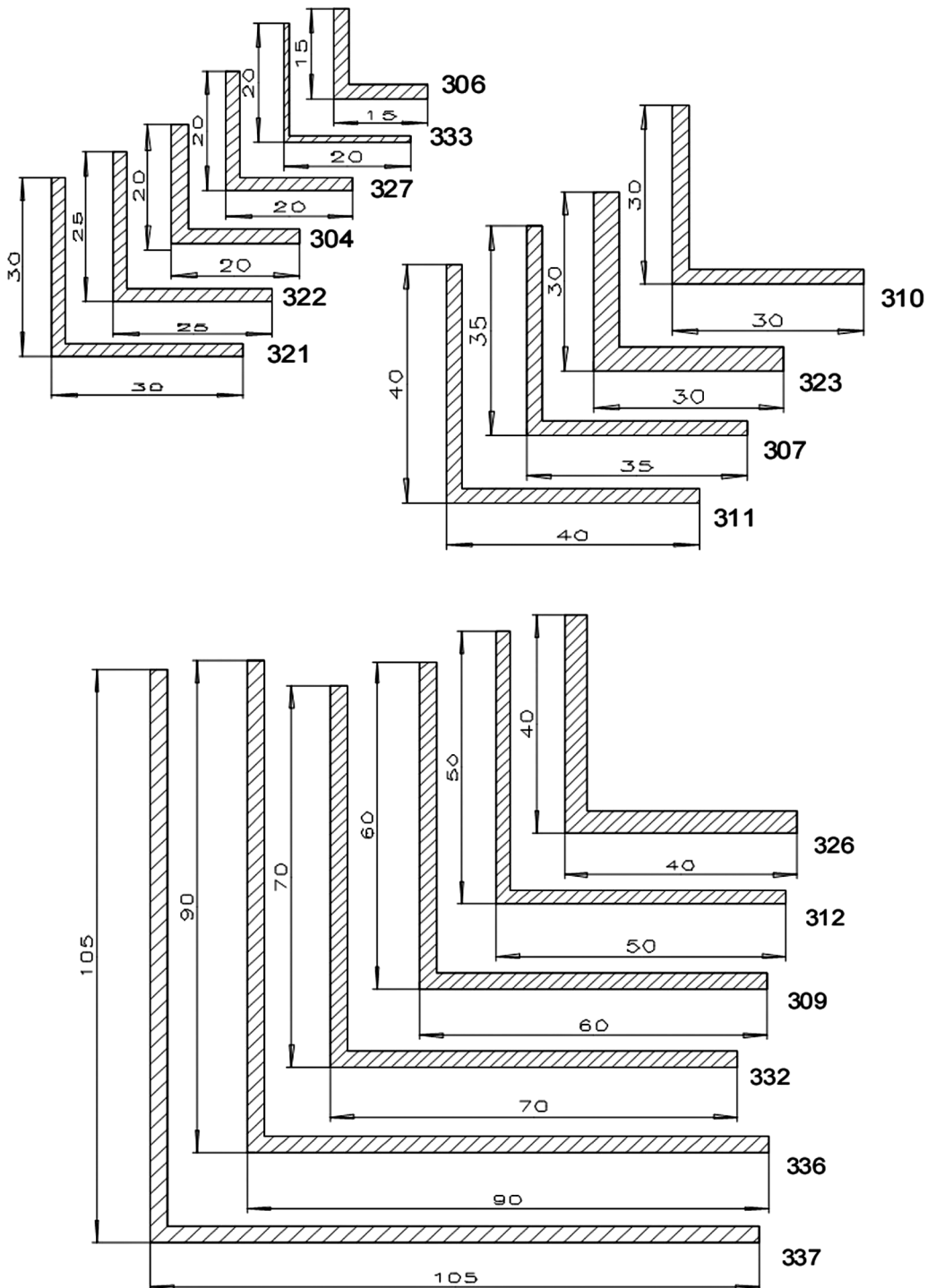



















Winkel

Angles

gleichschenkelig

Equal angles

Art.-Nr. Cat.-No.	Winkel Angles	Packung / lfm. Package / mtr.	Ausführung Execution	Lieferung Delivery
306	15 × 15 × 2,5 mm	60	○	
333	20 × 20 × 1,0 mm	60	○	
327	20 × 20 × 2,0 mm	60	○	
304	20 × 20 × 2,5 mm	60	○	
322	25 × 25 × 2,5 mm	60	○	
321	30 × 30 × 2,0 mm	60	○	
321	30 × 30 × 2,5 mm	60	D außen	
321	30 × 30 × 2,0 mm	60	D innen	
310	30 × 30 × 2,5 mm	60	○	
323	30 × 30 × 4,0 mm	60	○	
307	35 × 35 × 2,5 mm	60	○	
311	40 × 40 × 2,5 mm	60	○	
326	40 × 40 × 4,0 mm	60	○	
312	50 × 50 × 2,5 mm	60	○	
309	60 × 60 × 3,0 mm	30	○	
332	70 × 70 × 3,0 mm	30	○	
336	90 × 90 × 3,0 mm	30	○	
337	105 × 105 × 3,0 mm	30	○	

Winkel

Angles

ungleichschenklig

Unequal angles

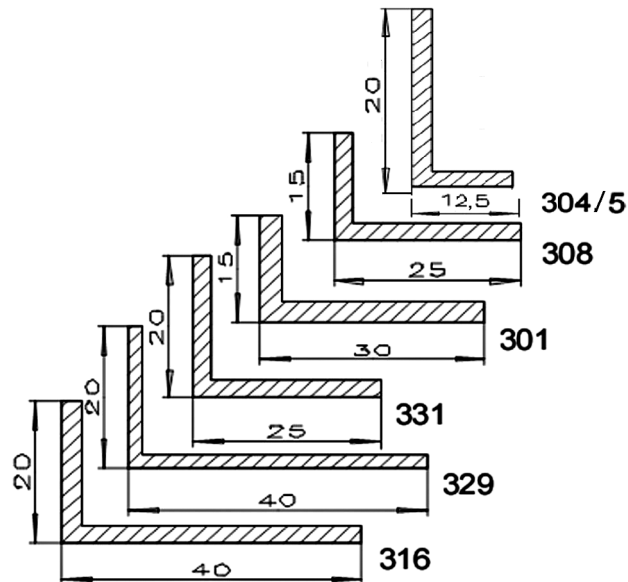
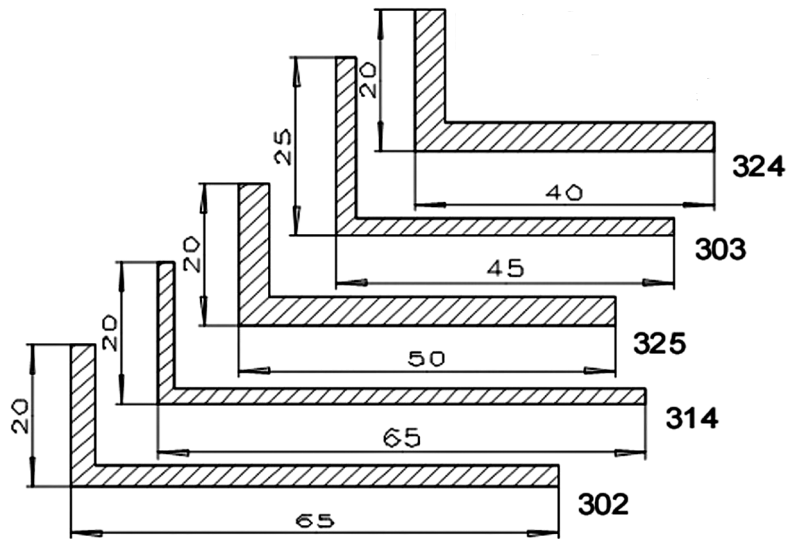













Winkel

Angles

ungleichschenlig

Unequal angles

Art.-Nr. Cat.-No.	Winkel Angles	Packung / lfm. Package / mtr.	Ausführung Execution	Lieferung Delivery
308	15 x 25 x 2,5 mm	60	○	
301	15 x 30 x 3,0 mm	60	○	
331	20 x 25 x 2,5 mm	60	○	
329	20 x 40 x 2,0 mm	60	○	
316	20 x 40 x 2,5 mm	60	○	
316	20 x 40 x 2,5 mm	30	D außen	
316	20 x 40 x 2,5 mm	30	D innen	
324	20 x 40 x 4,0 mm	60	○	
303	25 x 45 x 2,5 mm	60	○	
325	20 x 50 x 4,0 mm	60	○	
314	20 x 65 x 2,0 mm	60	○	
302	20 x 65 x 3,0 mm	60	○	
304/5	20 x 12,5 x 2,5 mm	60	○	

Winkel

Angles

ungleichschenlig

Unequal angles



















Winkel

Angles

ungleichschenlig

Unequal angles

Art.-Nr. Cat.-No.	Winkel Angles	Packung / lfm. Package / mtr.	Ausführung Execution	Lieferung Delivery
320	60 × 24 × 2,0 mm	60	○	
317	50 × 30 × 2,5 mm	60	○	
318	60 × 40 × 3,0 mm	30	○	
379	60 × 40 × 2,5 mm	30	○	
379	60 × 40 × 2,5 mm	30	D außen	
379	60 × 40 × 2,5 mm	30	D innen	
313	100 × 60 × 3,0 mm	30	○	
315	130 × 40 × 3,0 mm	30	○	
319	100 × 80 × 3,0 mm	30	○	
338	100 × 20 × 3,0 mm	30	○	
339	150 × 60 × 23,0 mm	30	○	
340	160 × 30 × 3,0 mm	30	○	
341	160 × 50 × 3,0 mm	30	○	
342	160 × 80 × 3,0 mm	30	○	
344	20 × 50 × 2,5 mm	30	○	
351	120 × 50 × 3,0 mm	30	○	

Winkel

Angles

gleichschenkelig

Equal angles

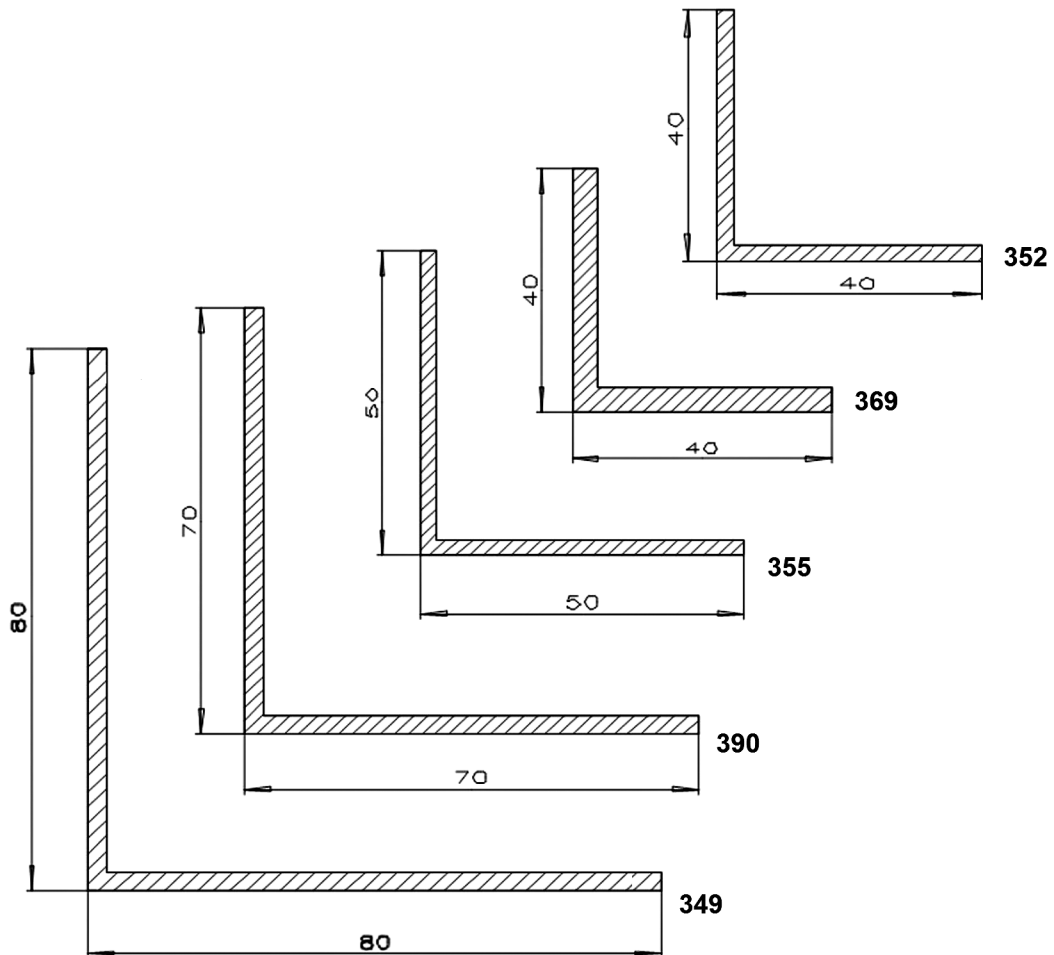





Winkel

Angles

gleichschenkelig

Equal angles

Art.-Nr. Cat.-No.	Winkel Angles	Packung / lfm. Package / mtr.	Ausführung Execution	Lieferung Delivery
352	40 x 40 x 2 mm	60	○	
369	40 x 40 x 3 mm	60	○	
355	50 x 50 x 2 mm	60	○	
390	70 x 70 x 2 mm	60	○	
349	80 x 80 x 3 mm	30	○	

Winkel

Angles

ungleichschenklig

Unequal angles

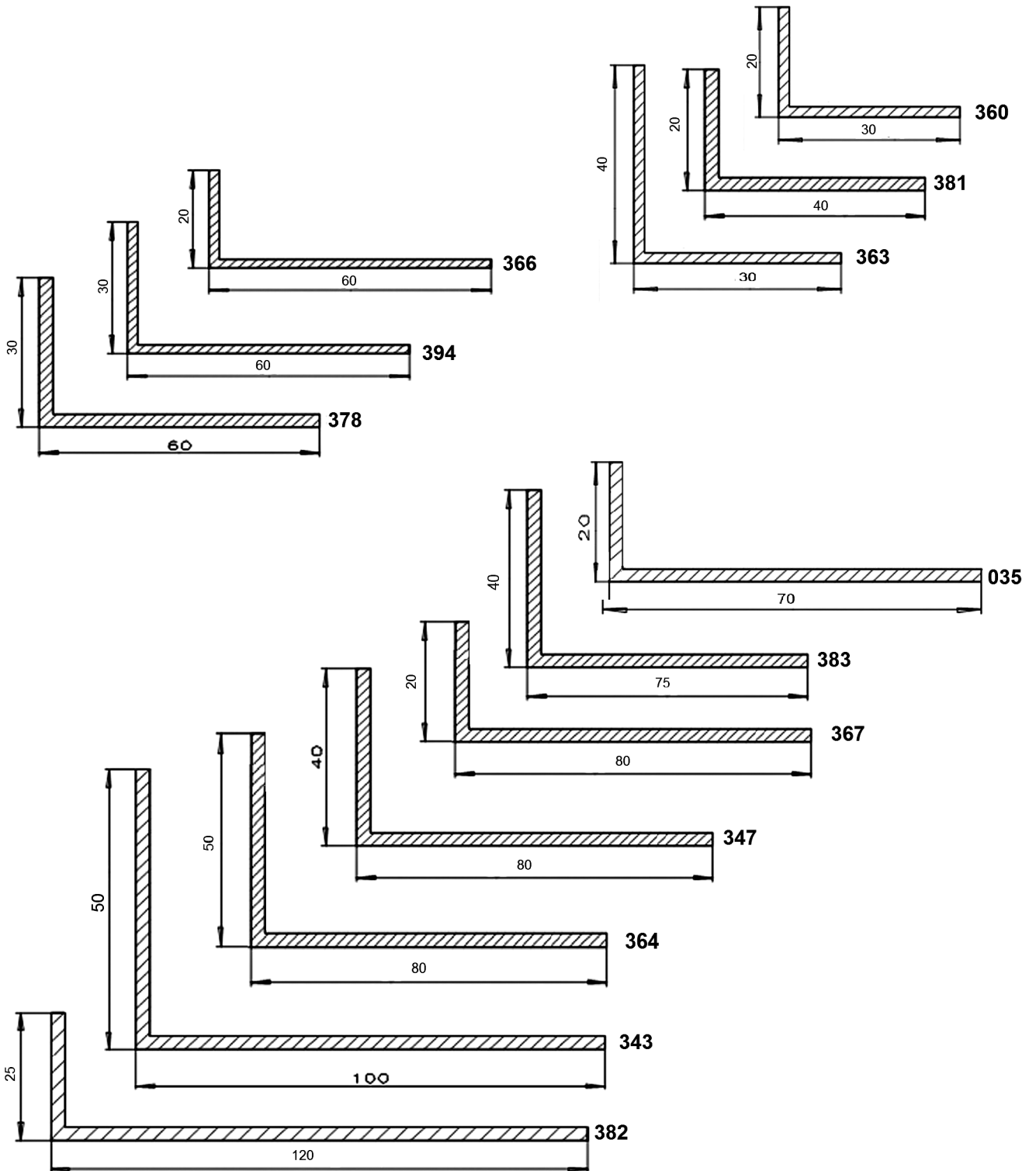



























Winkel

Angles

ungleichschenkelig

Unequal angles

Art.-Nr. Cat.-No.	Winkel Angles	Packung / lfm. Package / mtr.	Ausführung Execution	Lieferung Delivery
360	30 x 20 x 2 mm	60		
381	40 x 20 x 3 mm	60		
363	30 x 40 x 2 mm	60		
366	60 x 20 x 2 mm	60		
394	60 x 30 x 2 mm	60		
378	60 x 30 x 3 mm	60		
035	70 x 20 x 3 mm	60		
383	75 x 40 x 3 mm	30		
367	80 x 20 x 3 mm	60		
347	40 x 80 x 3 mm	30		
364	80 x 50 x 3 mm	30		
343	100 x 50 x 3 mm	30		
382	120 x 25 x 3 mm	30		

Winkel

Angles

ungleichschenlig mit Weichlippe

Unequal angles with a soft lip

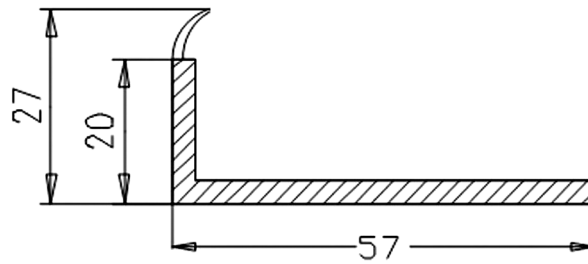

334

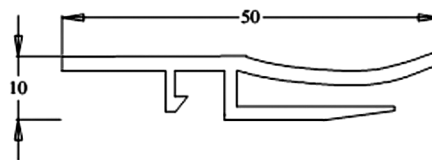

8826

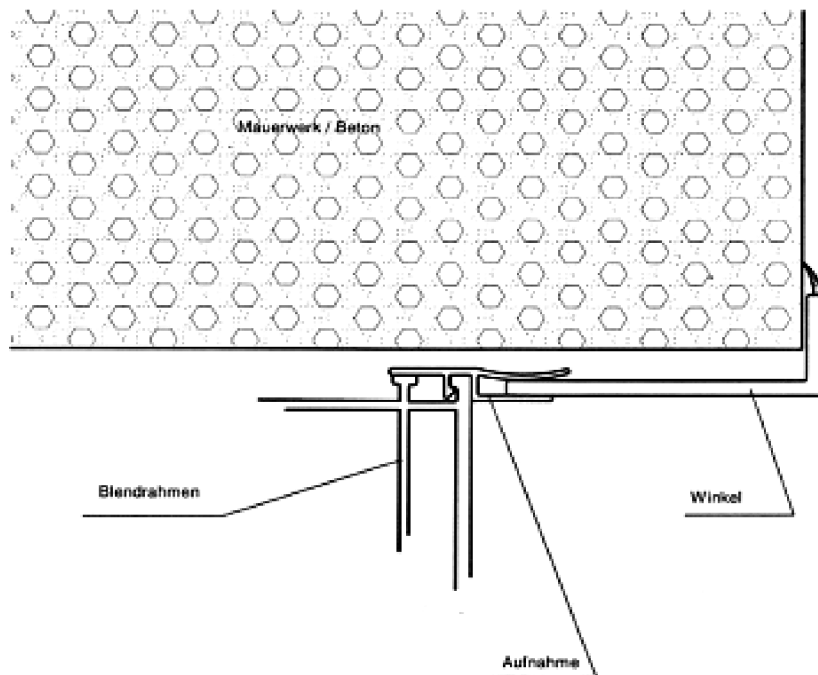





Winkel

Angles

ungleichschenkelig mit Weichlippe

Unequal angles with a soft lip

Art.-Nr. Cat.-No.	Winkel Angles	Packung / lfm. Package / mtr.	Ausführung Execution	Lieferung Delivery
334	57 x 20 x 3,0 mm	60		
8826	3 mm Aufnahme	60		

- Aufnahme 3 mm für diverse Systeme
- bei Bestellung bitte System angeben
- für System Schüco, Veka u.a.

- accommodation 3 mm for various systems
- please specify system when placing the order
- for system Schüco, Veka and others

Winkel

Angles

Hohlkammer 6 mm dick

Cavity, 6 mm thick

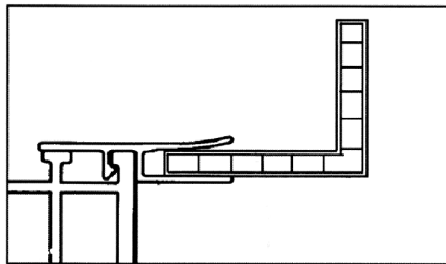
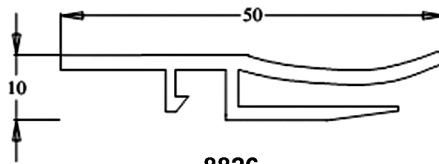
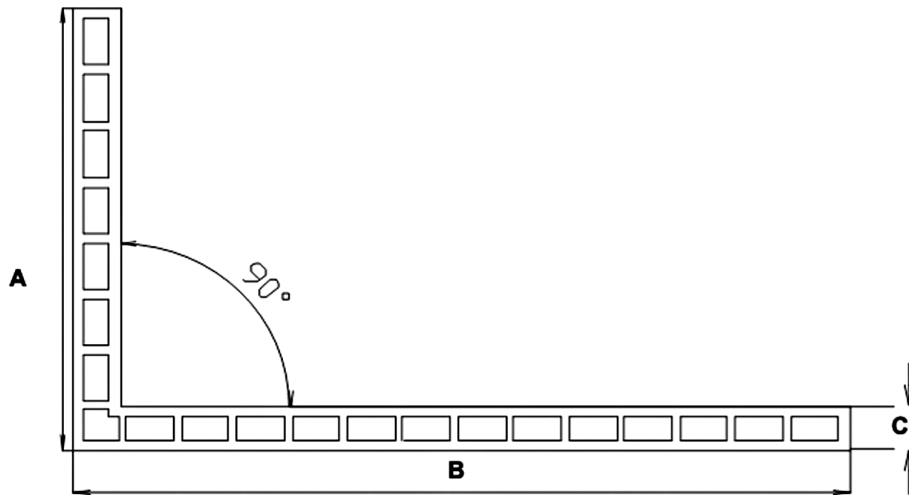









Winkel

Angles

Hohlkammer 6 mm dick

Cavity, 6 mm thick

Art.-Nr. Cat.-No.	Winkel Angles	Packung / lfm. Package / mtr.	Ausführung Execution	Lieferung Delivery
680/30	80 x 30 x 6,0 mm	30	○	
635/40	35 x 40 x 6,0 mm	30	○	
645/80	80 x 45 x 6,0 mm	30	○	
660/100	100 x 60 x 6,0 mm	30	○	
680/100	100 x 80 x 6,0 mm	30	○	
690/110	110 x 90 x 6,0 mm	30	○	
611/110	110 x 110 x 6,0 mm	30	○	
8826	3,0 - 6,0 mm Aufnahme	60	○	

Winkel
Angles

Winkel

Angles



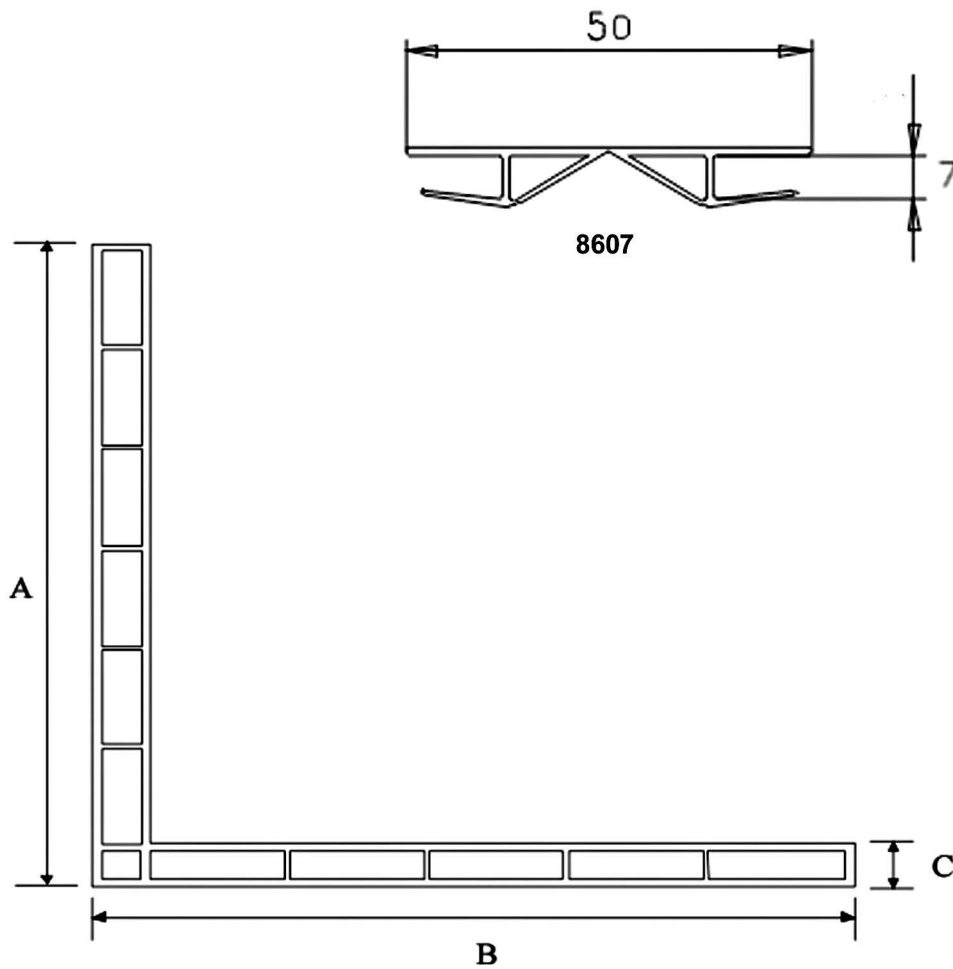

Hohlkammer 7 mm dick

Cavity, 7 mm thick



Winkel Angles

Hohlkammer 7 mm dick Cavity, 7 mm thick

Art.-Nr. Cat.-No.	Winkel Angles	Packung / lfm. Package / mtr.	Ausführung Execution	Lieferung Delivery
790/110	90 x 110 x 7,0 mm	30	○	
770/140	70 x 140 x 7,0 mm	30	○	
780/180	80 x 180 x 7,0 mm	30	○	
7200/150	200 x 150 x 7,0 mm	30	○	
8607	6 - 7 mm Aufnahme	60	○	

- Aufnahme 6–7 mm für diverse Systeme
- accommodation 6–7 mm for various systems

Winkel

Angles

Knickwinkel auf Rolle

Roll of flat strip with buckling angle

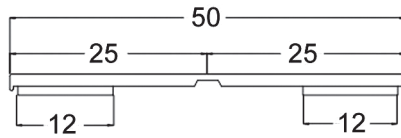

2525

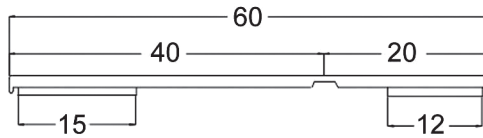

2040

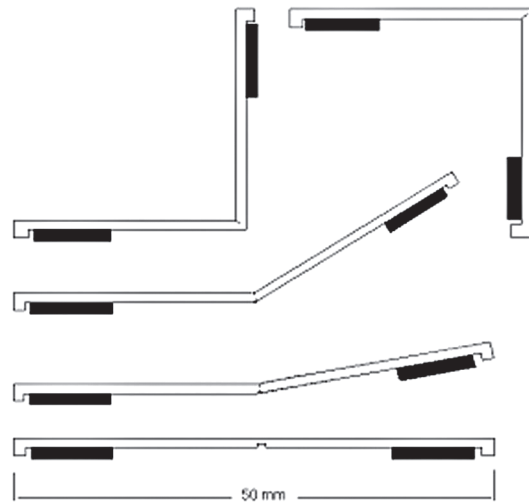
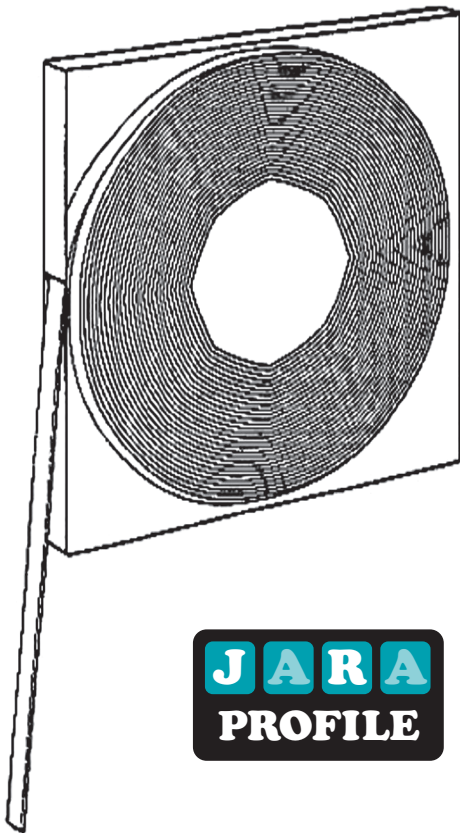









Als Innen- oder Außenwinkel einsetzbar

Winkel Angles

Knickwinkel auf Rolle

Roll of flat strip with buckling angle

Art.-Nr. Cat.-No.	Winkel Angles	Packung / lfm. Package / mtr.	Ausführung Execution	Lieferung Delivery
2525	25 / 25 x 1,5 mm	150		
2040	40 / 20 x 1,5 mm	150		
2525	25 / 25 x 15 mm	50		
2525	40 / 20 x 18 mm	50		

- Rollenlängen 150 lfm, SKS Ausführung Standard

SKS = Standardausführung für Außen und Innen

- Zubehör: Speziälschere zum sauberen Zuschnitt
- Knickwinkel Standard selbstklebend für Innen- und bedingt für den Außeneinsatz auf Rolle zur verschnittfreien Verarbeitung.

- Roll lengths 150 meters SKS-standard

SKS = standard for exterior and interior mounting

- Accessories: Special scissors for a clean cut
- Buckling angle, standard, self-adhesive for interior and for limited exterior use on a roll for waste free application

Winkel

Angles





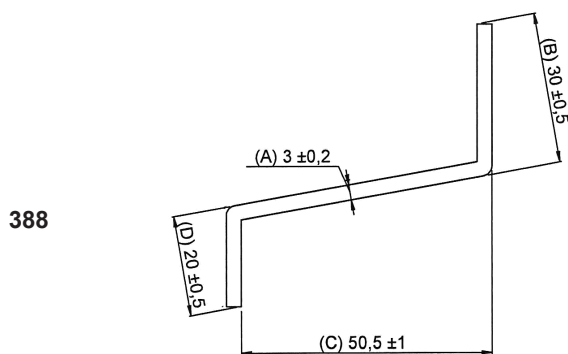
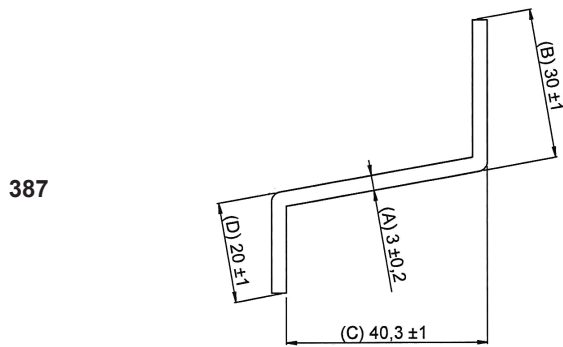
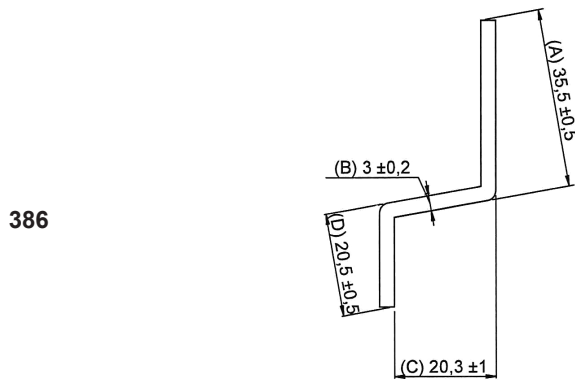
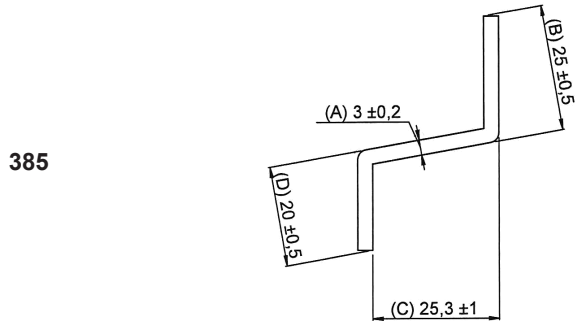

Z-Profile

Z-profiles



Winkel Angles

Z-Profile Z-profiles

Art.-Nr. Cat.-No.	Winkel Angles	Packung / lfm. Package / mtr.	Ausführung Execution	Lieferung Delivery
385	20 × 25 × 25 mm	60	○	
386	20 × 25 × 35 mm	60	○	
387	20 × 40 × 30 mm	60	○	
387	20 × 40 × 30 mm	60	●	
388	20 × 50 × 30 mm	60	○	
388	20 × 50 × 30 mm	60	●	

Winkel

Angles

mit Sollbruchstellen

with predetermined breaking points

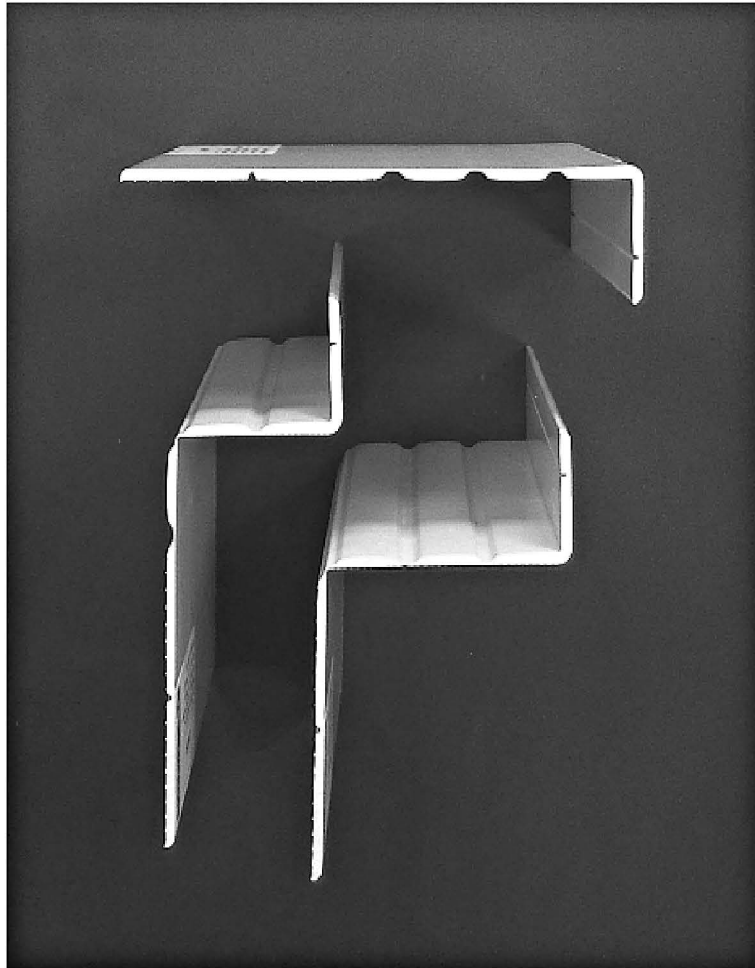

Winkel
Angles

Art.-Nr. Cat.-No.	Winkel Angles	Packung / lfm. Package / mtr.	Ausführung Execution	Lieferung Delivery
3380551	100 × 20 × 2,3 mm	30	○	